

PTS

PassThru Series Waist High Turnstile

Service & Installation Manual



Note: Successful turnstile installation depends on reading this manual.

Important Note: Please keep this service manual after installation. If an installation is done by a construction company or outside installer, please pass this book along to the end user. This book is required for maintenance, troubleshooting, and repairs.

Important Electrical Information

Installation of the control head mechanism into the turnstile requires a grounding-type outlet receptacle installed inside of the frame or cabinet through the provided conduit access points.

To reduce the risk of electric shock, this equipment has a grounding type plug that has a third (grounding) pin. This plug will only fit into a grounding type outlet. If the plug does not fit into the outlet, contact a qualified electrician to install the proper outlet. Do not change this plug in any way.

Additionally, the MS2-H50 power supply from this appliance must be grounded to the frame of the turnstile. Utilize the green colored grounding screw threaded into the grounding tab located near the power supply along with the provided grounding wire from the power supply to ensure the equipment is proper grounded.

PT-S FASTENER LIST

QTY. 4 - 3/8 – 16 x 3 3/4" WEDGE TYPE ANCHORS

QTY. 3 - 5/16 – 18 X 3/4 BUTTON HEAD (Arms to Turnstile)

Table of Contents

Important Electrical Information	2
PTS Dimension Drawing	5
PTS Foot Print	6
PTS Installation	7
Concrete Anchor Installation	8
6500 Series Control Head Information	9
Control Head Parts Breakdown	10
Control Head Parts List	11
6500 Series Control Head Configurations	12
Locking Bar Information	13
Shock Adjustment / Replacement	15
Control Head Electrical Information	16
Wiring Diagram	17
Wiring Legend	18
Overview of the Access Window	19
Device Settings of the 6500 Series Control Head	21
Limit Switch Information	23
Maintenance & Cleaning	24
Testing Procedures	25
Troubleshooting	26
Proper Turnstile Usage	28
Warranty Information	29
Appendix: Spec. Sheets, Options, Etc.	

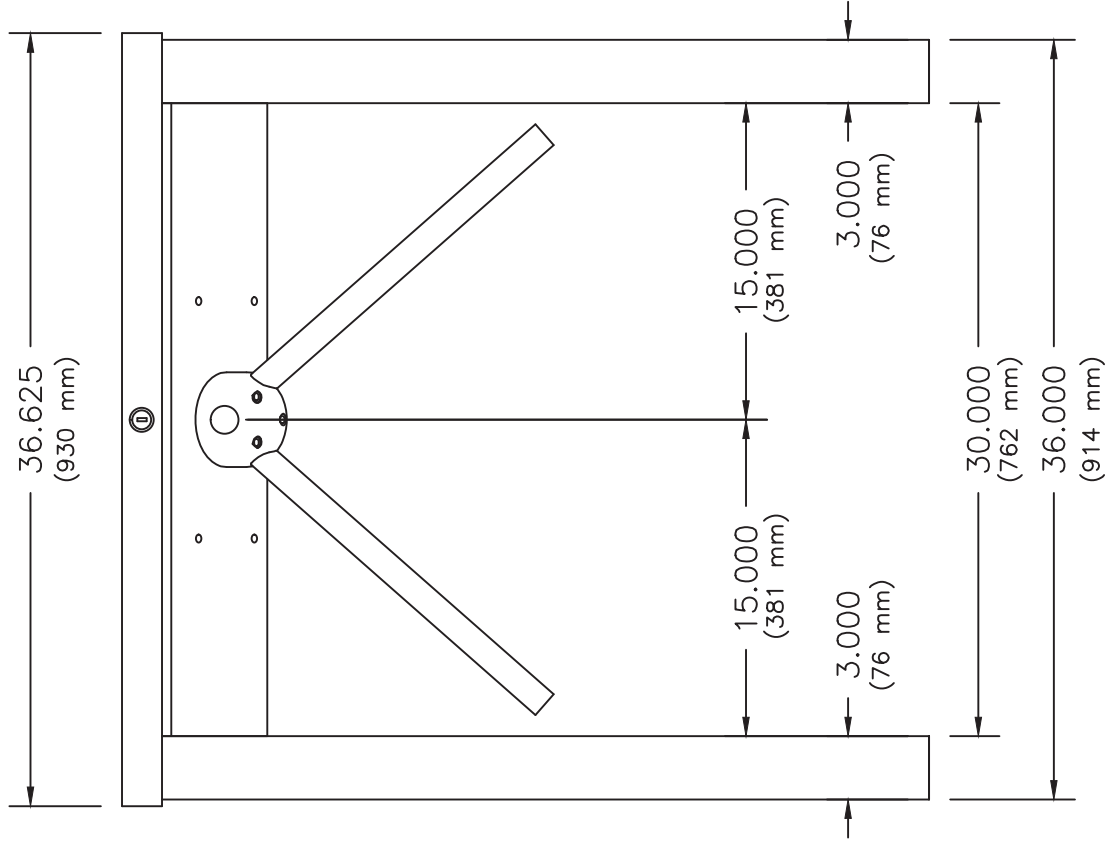
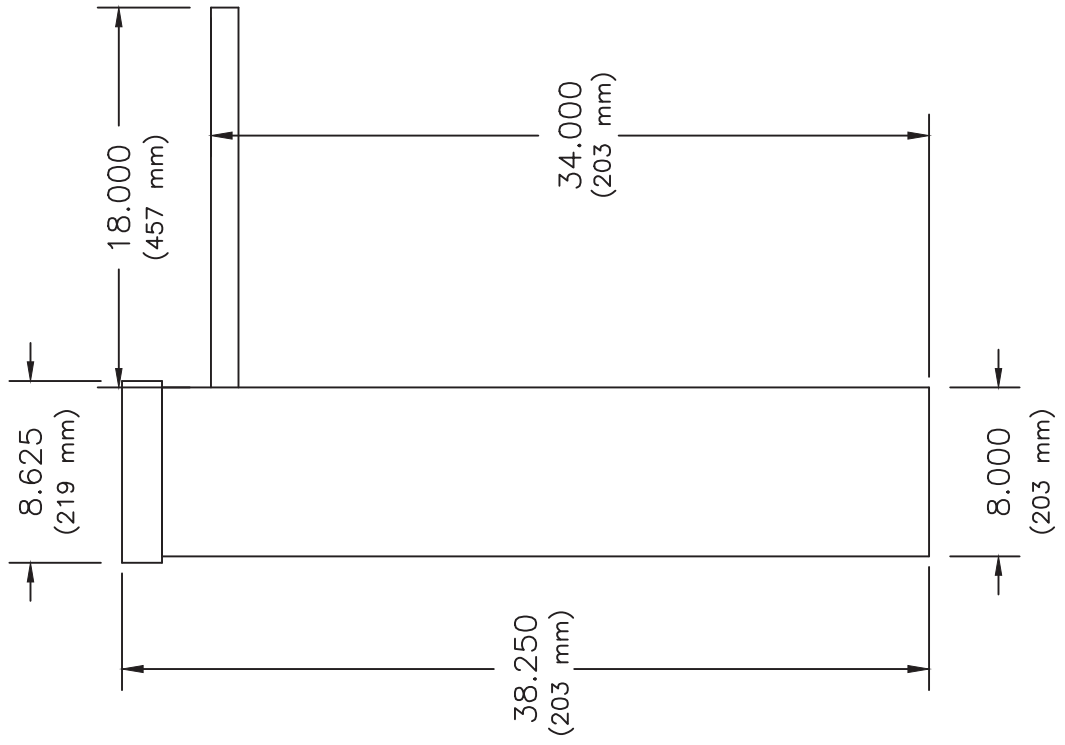

1. Floor should be level +/- 1/16" if not, turnstile must be shimmed. **Caution** bolting turnstile or handicapped gate to an unlevel floor could cause it to work improperly.
2. Place template (or turnstile upright) in the exact location to be mounted and use a center punch to mark location of each of the four holes to be drilled in the floor.
3. Drill four 3/8" holes 4" deep and remove all concrete dust from holes.
4. Place turnstile or handicapped gate in the correct location and install SS wedge type anchors supplied. Torque nuts minimum of 50 foot pounds.
5. Wire turnstile or handicapped gate with 110 volt minimum 2 amp GFI circuit to terminals provided. **These must be grounded.** Most card readers provide normally open contacts which are activated upon acceptance of card presented. These contacts are to be wired to terminals. See electrical drawings supplied.
6. Please give owner all maintenance and parts manuals supplied with this equipment.

Concrete Anchor Installation

Instructions for Using Wedge Anchors

Determine the appropriate wedge anchor length for your project.

1. Add:
 - to-
 - The thickness of material to be fastened
 - to-
 - The minimum embedment required
 - to-
 - The thickness of the nut and washer (about one anchor diameter).
2. Once you have determined the appropriate wedge-type-anchor length, drill your hole using a bit with the same diameter, 1/2" deeper than the anticipated anchor embedment.
3. Clean the drilled hole of any debris.
4. Thread the nut and washer until the nut is flush with the top of the anchor.
5. Hammer it into position (nut and washer flush with the surface of the material).
6. Tighten finger completely and then take an additional 3-5 turns with the wrench.
7. If the anchor spins in the hole, force it up using a screwdriver until the clip binds into the concrete.

Thunderstud® Wedge Anchor Technical Information

Diam. & Length	Min. Embedment	Thread Length
1/4"	1-1/8"	3/4"
3/8"	1-1/2"	7/8"
3/8"	1-1/2"	1-1/8"
1/2"	2-1/4"	1-1/4"
1/2"	2-1/4"	1-1/4"
5/8"	2-3/4"	2"
5/8"	2-3/4"	2"
5/8"	2-3/4"	2"
3/4"	3-1/4"	2"
3/4"	3-1/4"	2"
3/4"	3-1/4"	2"
7/8"	3-7/8"	2-1/4"
1"	4-1/2"	2-1/4"
1-1/4"	5-1/2"	3-1/4"

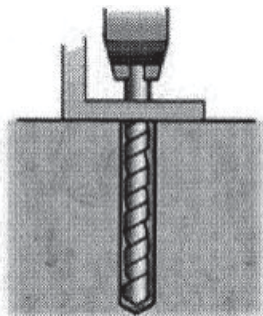

1. Drill hole 1/2" to 1" deeper than anchor embedment. Clean hole of debris.

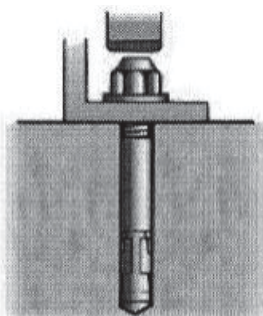

2. With nut threaded past the end of stud, hammer into position.

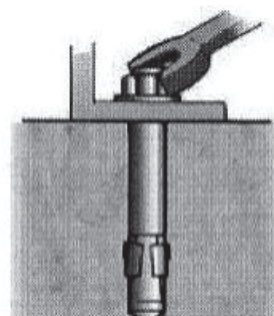

3. Tighten finger tight plus an additional 3-5 turns with wrench.

6500 Series Control Head Information

All of our turnstiles and ADA gates operate with a mechanism called the 6500 series control head. This sturdy and easy to maintain drive for the turnstile has replaced all previous model control heads. It is adaptable to any existing turnstile and comes with each new turnstile purchase. This control head can be configured in multiple ways to accommodate the security requirements of each individual job site.

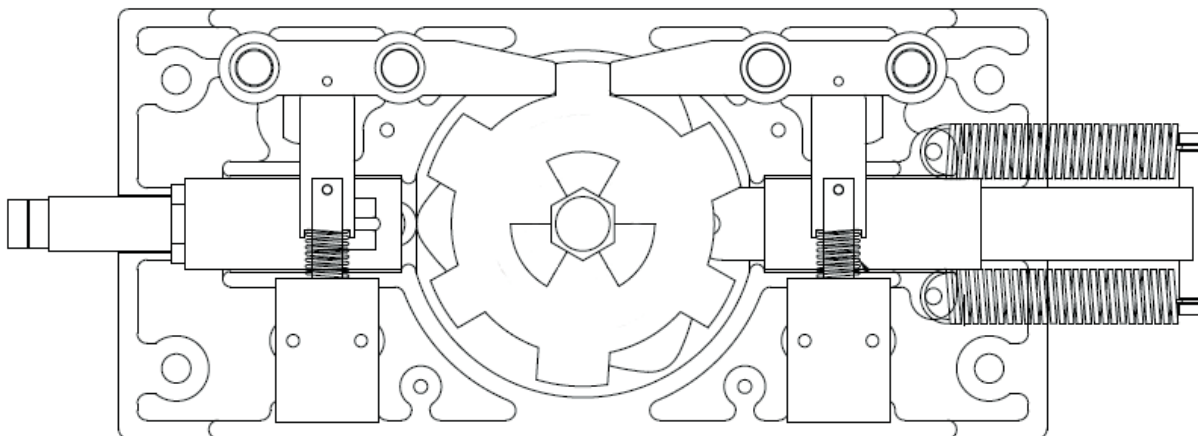

An internal view of an electronically controlled two-way 6500 series control head.













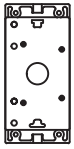

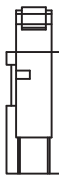

While the head can be configured for mechanical (no electronics) operation, the turnstile's security potential is reached in the case of an electronic two way control head. In this instance, each rotational direction is independently unlocked. Configured properly, this control head will allow for one rotation per valid entry request. Our anti-backup cams are designed so that it is impossible to become trapped within the turnstile when properly installed.

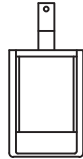
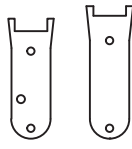
Each control head comes pre-configured to your specific needs based off of a directional sheet that is filled out before shipment. The heads are delivered pre-wired, tested, and adjusted to our factory recommendations. Installation is simple: connect inputs from access control devices into the logic controller and plug the unit's power supply into a 110-240VAC receptacle. The power supply will automatically set itself to function on your local voltage and convert it to 24VDC.

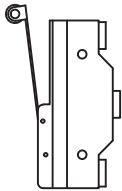
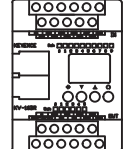

Note: Proper turnstile operation requires a dry, normally open momentary contact closure (of one second or less).

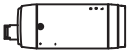
Complete control heads are available. Contact us for pricing details.

 <p>Index Pin Assembly All Models 6532</p>	 <p>Index Pin Tubing All Models 6520</p>	 <p>Index Spring WH Models: 1106 FH Models: 1108 ADA Gates: 1107</p>	<p>\$108.19</p>	<p>\$26.90</p>	<p>\$5.31 \$5.31 \$5.31</p>
 <p>Control Head Casting Top Casting: 0372 Bottom Casting: 0373</p>	 <p>Top Casting Bearing All Models 1641 (1641-2RSNR)</p>	 <p>Bottom Casting Bearing All Models 7208 (6007RSNR)</p>	<p>\$179.10 \$179.10</p>	<p>\$24.81</p>	<p>\$23.22</p>
 <p>Hydraulic Shock Absorber 427/430/T80/WH/ADA 6560 (ACE MA225) 439/448/P60 6561 (ACE MA600)</p>	 <p>Shock Housing 427/430/T80/WH/ADA 6535 439/448 6541</p>	 <p>WH Arm Adapter Proximity Sensor Cam 2030</p>	<p>\$149.72 \$224.90</p>	<p>\$154.26 \$162.00</p>	<p>\$57.74</p>
 <p>Solenoid All Models 6051 (Detroit D4A53717-83)</p>	 <p>Locking Bar Linkage Fail Lock: 6518 Fail Open: 6519</p>	 <p>Locking Bar All Models 0381</p>	<p>\$59.59</p>	<p>\$10.00 \$10.00</p>	<p>\$34.23</p>
 <p>Solenoid Springs Fail Open: 6510 Fail Lock: 6016</p>	 <p>Limit Switch Cam Standard: 2267 ADA Gate: 2268 One-Way: 2269</p>	 <p>Limit Switch Standard: 2180 OMRON Z-15GW2-B7-K One-Way: 1700 OMRON BZ2RW825-A2</p>	<p>\$7.35 \$7.35</p>	<p>\$25.00 \$27.87 \$58.92</p>	<p>\$24.72 \$58.92</p>
 <p>Logic Controller 6789 (KEYENCE KV16DR)</p>	 <p>Cam Assembly (specify limit/prox) 427/430/T80/WH: 0401 7/8" Hex 439/448/P60: 0407 1-1/4" Hex ADA Gate (specify model): 0402 7/8" Hex</p>	 <p>Power Supply 100-240VAC 24VDC 2.1 AMP 0781 (KEYENCE M52-H50)</p>	<p>\$210.00</p>	<p>\$215.77 \$238.05</p>	<p>\$150.00</p>
 <p>Proximity Sensor (PNP) 7211 (SICK 1040765)</p>	 <p>Proximity Sensor Bracket 6589</p>		<p>\$150.83</p>	<p>\$190.75</p>	<p>\$10.00</p>

All pricing subject to change without notice. All parts orders are shipped via UPS. Expedited shipping available upon request. The above prices do not include shipping. All parts orders under \$500.00 require credit card payment before shipment.

Date: 10/19/12

6500 Series Control Head Configuration Information

The 6500 series can be configured in a number of different ways. All turnstiles operating with the 6500 series control head self center and hydraulically shock to the home position to prevent damage or injury.

Manual both ways: Turnstile rotates freely in both directions. This unsecure configuration is used as a means to direct traffic through one area. Full height turnstiles can be purchased with a lockout bar which would allow end user to lock the turnstile with a standard pad lock.

Manual one way: Turnstile rotates in one direction but not the other. This configuration is great for an exit way.

Electronic one way with free exit: Turnstile rotates freely in one direction and requires access credentials for the other. This configuration is suitable for secure entry and unsecure exit.

Electronic one way with no exit: Turnstile requires access credentials for one direction and allows no passage in the other. This configuration is suitable for a secured entryway with an alternate means of exit.

Electronic two way: Turnstile requires access credentials for both directions. This configuration is perfect for locations requiring secured entry and exit passage.

Fail lock: Upon power failure, turnstile will remain locked in one or both directions. This is convertible to fail open by ordering an alternate linkage. This can also be known as fail secure.

Fail open: Upon power failure, turnstile will remain unlocked in one or both directions. This is convertible to fail lock by ordering an alternate linkage. This can also be known as fail safe.

Key override: This option is for a location that the security requirements may change. The key override option is not intended for everyday use

6500 Series Control Head Locking Bar Information

Any number of configurations is possible on the 6500 series control head. In the case of an electronic two way head, two independent locking mechanisms are in place. The following diagram indicates which direction unlocks from which locking mechanism. A logic controller or key override is needed to unlock the control head in each direction it is configured to lock in.

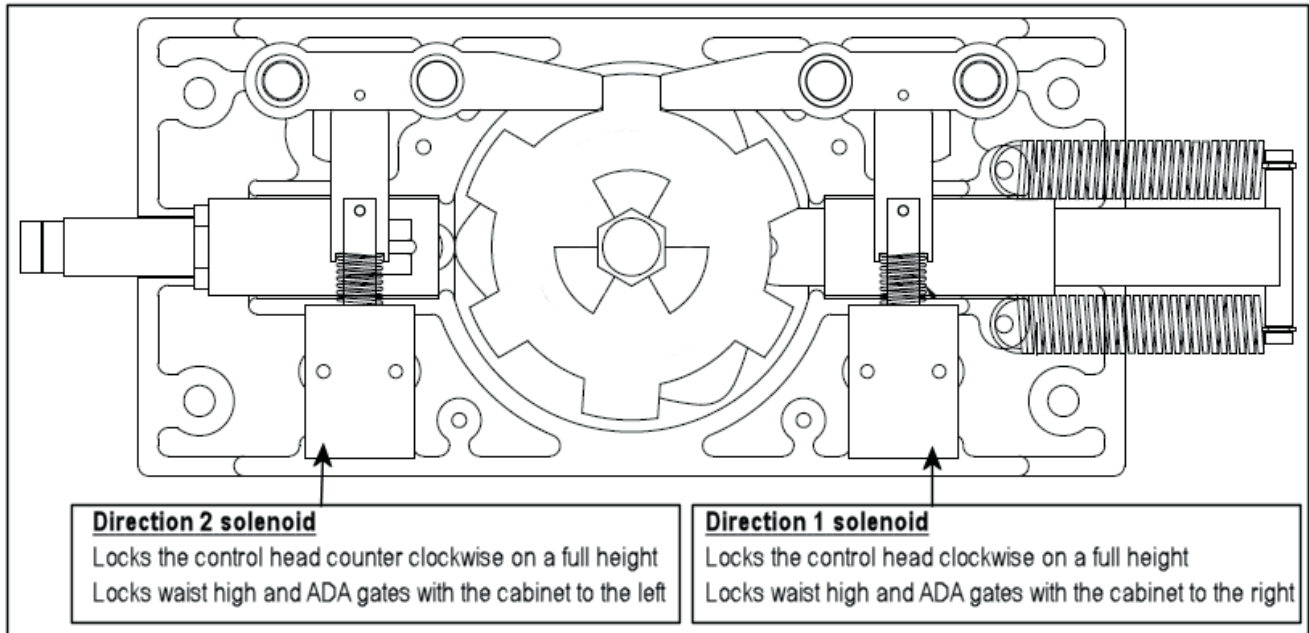

If removing the locking bar becomes necessary for any reason, two methods can be used. The easiest method is to punch the 1/2" dowel pin out from the bottom side of the control head. This releases the locking bar from the casting. An alternate approach would be to remove the (4) 1/4-20 socket head cap screws from the casting and remove the lid.

When installing or replacing the locking bars into the control head, be sure to take special care to align the solenoid spring (shown below) or it will not pivot properly.

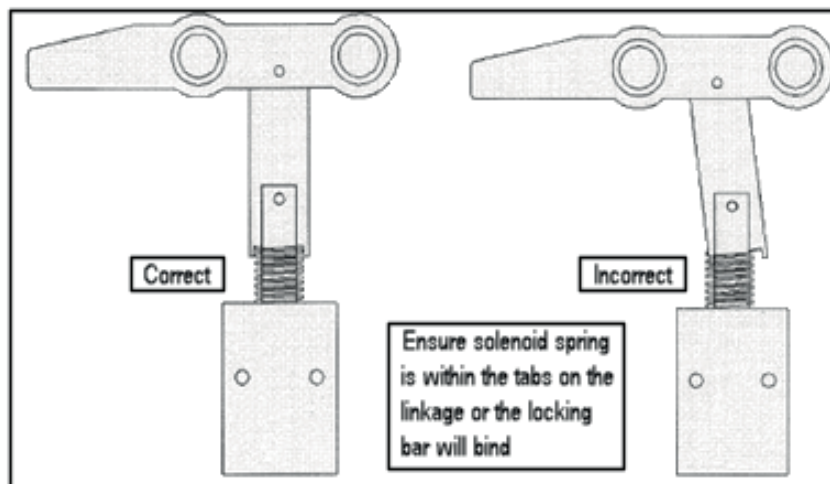

Power Failure State Configuration (Fail Lock / Fail Open)

Each direction on a control head can be independently configured to open or lock upon power failure. The fail status configuration is based on the pivot point used on the locking bar as well as the linkage and solenoid spring used. Control heads are preconfigured in our factory before shipment based on a direction sheet filled out by the end user. In the event a fail status field change is needed, a different linkage and spring will be required (the part numbers are noted in a table below). Control heads can also be returned to the factory for reconfiguration for a fee of parts plus approximately 1 hour of labor if desired.

Description	Part Number
Fail open linkage	6518
Fail lock linkage	6519
Fail open solenoid spring	6510
Fail lock solenoid spring	6016

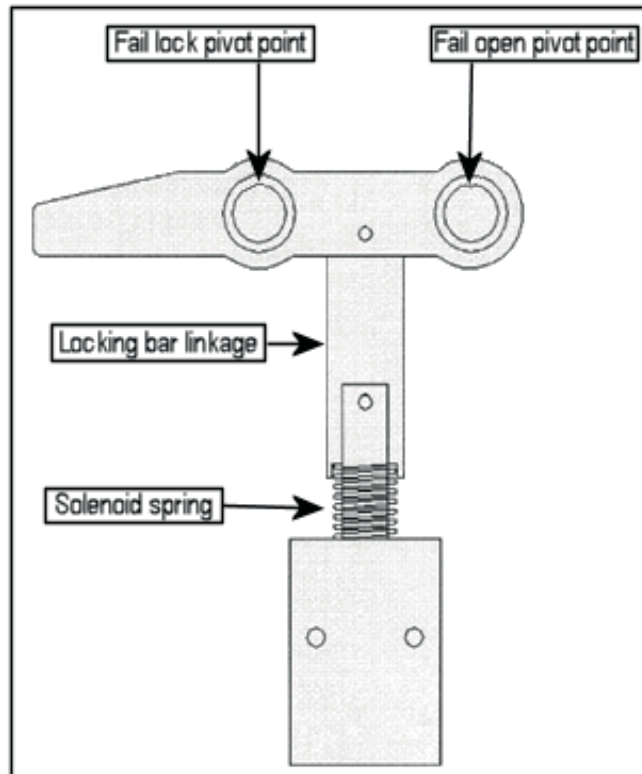

Note: As a reference, it may be important to know that some vendors use different terms for fail status. Fail open is also known as fail safe, while fail lock is also known as fail secure.

6500 Series Control Head Shock Adjustment and Replacement

Our turnstiles come with hydraulic shocks in order to alleviate wear on the control head. These shocks allow the turnstile to return to the center position without slamming into place. Although we adjust these in the factory, different environments may require additional field adjustment.

The shock is located adjacent to the index pin. To adjust the shock, loosen the set screw pointed upwards and adjust the dial. The set screw points at the current setting. A lower number yields more shock, whereas a higher number yields less shock. The table below indicates approximate shock settings for each type of product. Individual installations may vary.

Product	Approximate Shock Setting
Full Height	0-2
Waist High	5-6
ADA Gate	4-5

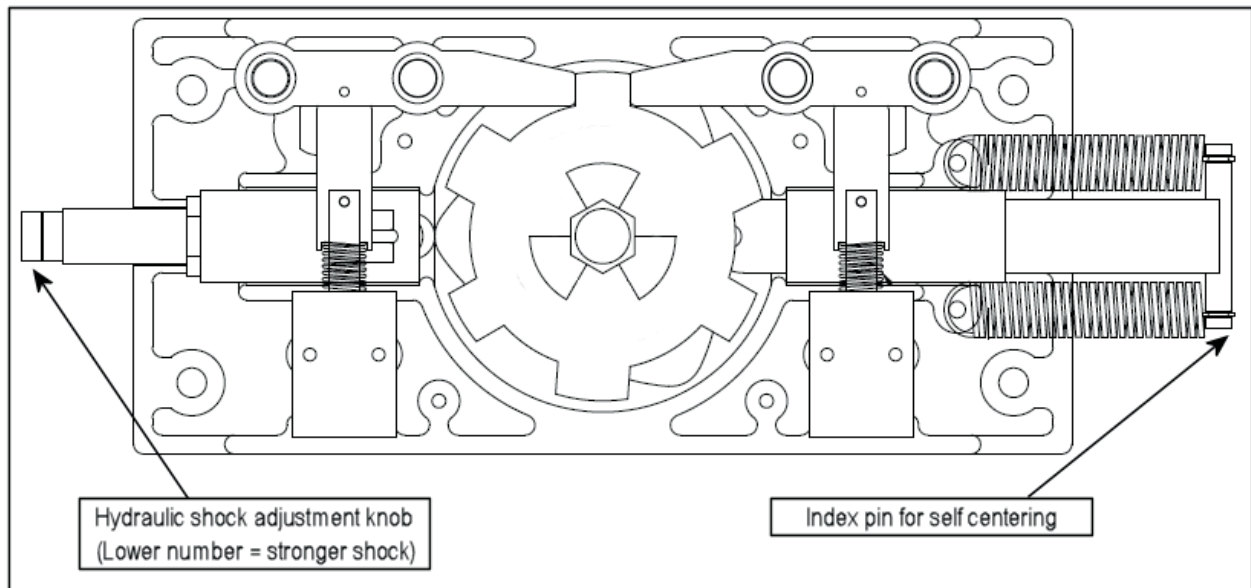

Should the shock need replaced, be sure not to fully thread the shock into the shock housing. Instead, thread the shock until it no longer spins, and then back the shock out approximately 1 ½ - 2 turns until the set screw is facing up. Lock down the shock with the provided nut, and then make field adjustments to the shock strength.

Some larger model turnstiles use an alternate, heavier shock. They adjust in the exact same fashion, but instead of being held in place with a nut, a ¼-20 set screw is used in the shock housing.

6500 Series Control Head Electrical Information

Each electronic control head comes with a power supply, a programmable logic controller (PLC), limit switches (or proximity sensors) and solenoids. For safety purposes, it is recommended that you read all literature on the electrical components before attempting to install the control head into a turnstile.

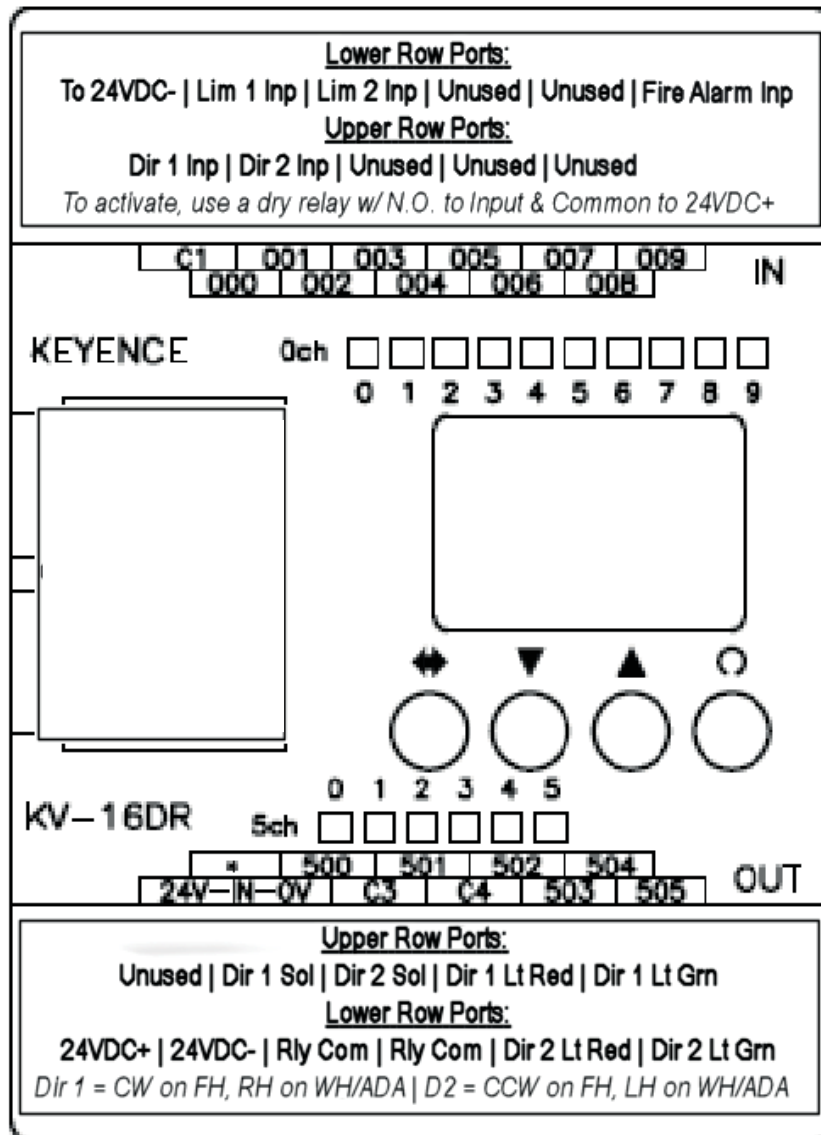

Note: Access control devices need to provide a momentary, normally open dry contact of one second or less. A longer signal can cause more than one person to be able to pass through the turnstile. If you are unable to provide a contact of one second or less, an onboard signal converter will automatically change the signal length to .1 seconds. However, the ability to hold the relay open is lost while that feature is active.

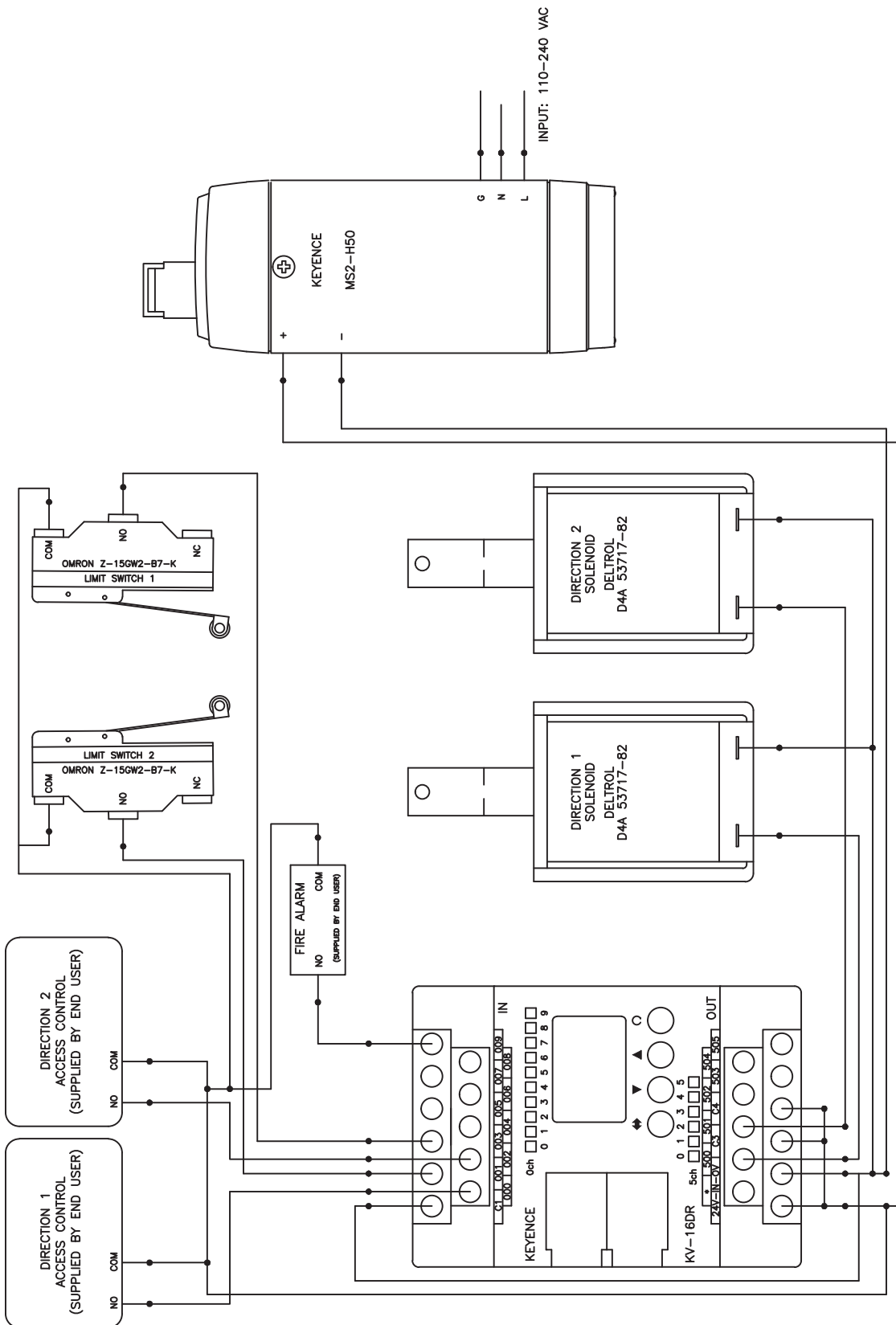

11/1/12

6500 Series Control Head Wiring Legend

Since each control head comes pre-wired, only access control and fire alarm should need to be connected to the board. If you are unable to fit wires for access control on the 24VDC+ input on the board, the voltage can be picked up directly from the power supply or from the relay commons (C3 & C4) on the board (C4 may not have voltage depending on options purchased. There will be a red jumper to C4 if there is). You may also run a jumper from 24VDC+ to any unused input to give additional contacts if needed.

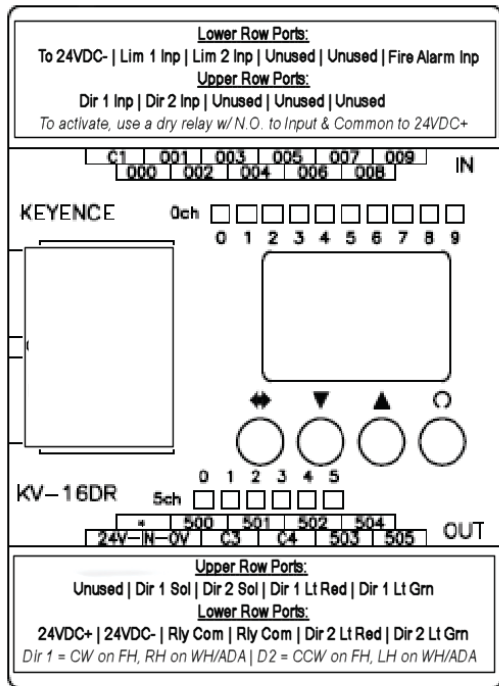

6789 Wiring Legend

Definitions:

- Direction 1: Clockwise on a full height, right hand cabinets on waist highs / ada gates
- Direction 2: Counter clockwise on a full height, left hand cabinets on waist highs / ada gates
- Limit 1: Cancels direction 1 activation
- Limit 2: Cancels direction 2 activation
- Fire Alarm: Unlocks both directions while active

Inputs are triggered with 24VDC+ (PNP). Use dry normally open relays to activate. 24VDC+ to the common leg and the input you wish to trigger to the normally open leg.

BE SURE TO DISCONNECT POWER BEFORE WIRING THE BOARD.

Input Side

- C1: To 24VDC -
- 000: Direction 1 Input
- 001: Limit 1 Input
- 002: Direction 2 Input
- 003: Limit 2 Input
- 004: Not Used
- 005: Not Used
- 006: Not Used
- 007: Not Used
- 008: Not Used
- 009: Fire Alarm Input

Output Side

- *: Unused
- 24V-IN-0V: Input voltage
- C3: Common for 500 & 501 Outputs
- C4: Common for 502-505 Outputs
- 500: Direction 1 Solenoid
- 501: Direction 2 Solenoid
- 502: Direction 1 - Red Light
- 503: Direction 2 - Red Light
- 504: Direction 1 - Green Light
- 505: Direction 2 - Green Light



Note: Directional status outputs are unaffected by optional key overrides as the override occurs outside of the logic controller.

Overview of the Access Window

On the logic controller, an access window is available to change and adjust many different values. Each value is referred to as a “device”. The window comprises of 3 primary areas: The device selector window, operation keys, and the main display window.

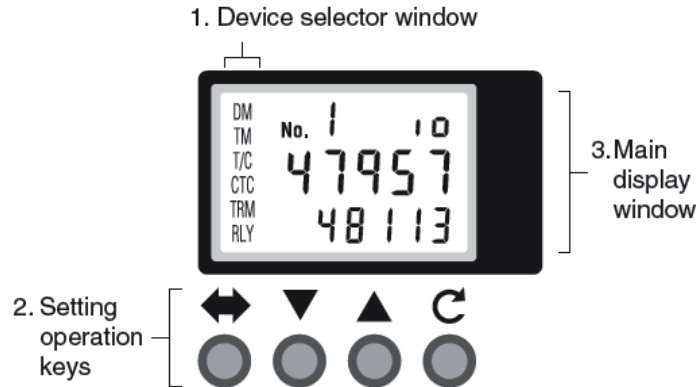

Although the logic controller is capable of many functions, all of the devices that the control head operates from are accessed in “Device Mode”. When device mode is active, the display screen will show DM in the top left corner.

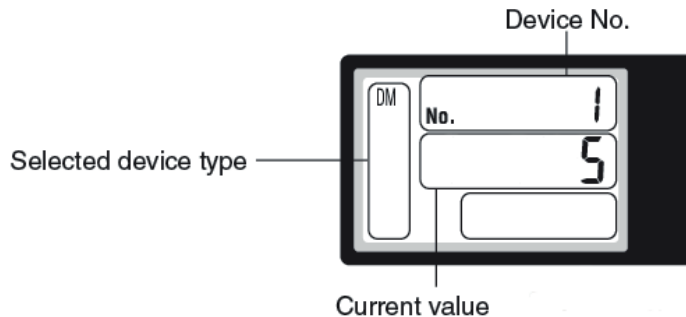

That being said, it is possible to stray from the device mode settings. In the selected device type section of the access window, DM, TM, T/C, CTC, TRM, and RLY are all possible selections to load. Again, we are only using DM (device mode) with the 6500 series control head.

Should you find that you accidentally have loaded any other selected device type, simply press  to scroll until you have once again loaded the DM type.

In addition to the device mode window, system mode can be accessed as well.

Indicates that the system mode is selected.

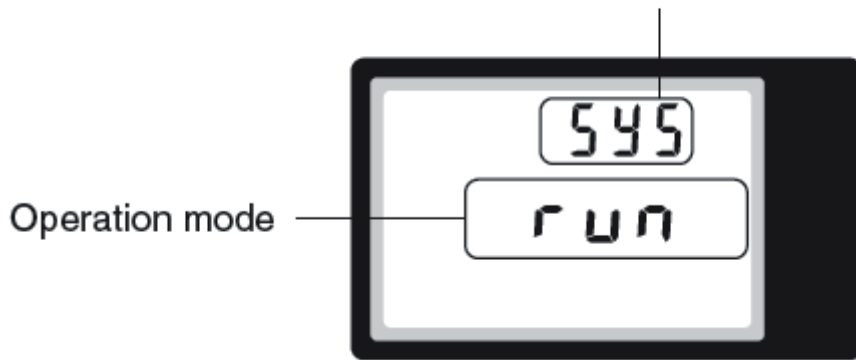

Although under normal circumstances you should never encounter this window, if by accident you should happen to come across it, simply press the up or down arrow until the window reads “run”. Press and hold the **C** button for 3 seconds, and the display will return to device mode.

Additionally, should for any reason the display lettering become red instead of green, you will need to access system mode to run the program in this fashion. Holding the **↔** key while pressing up and down allows you to change between system mode and device mode. A third mode, which will display TRM on the left side of the screen, can also be accessed. Cycle through until the appropriate mode is displayed.

Finally, it is possible to lock the keypad. Should you inadvertently do so, press and hold the **↔** button and an arrow key together for 3 seconds to unlock the keypad again.

Device Settings of the 6500 Series Control Head

While working within device mode, two primary values should be considered. On the top of the display, the selected device is shown. The 6500 series control head settings can be adjusted with devices 0 – 7.

Pressing the up or down arrows allow you to select which device you wish to modify. Pressing and holding the **C** key for 3 seconds loads the modification window. While modifying, the digits on the window begin to flash. Pressing **←** will move the cursor in a digit. Select the correct digit to modify, then use the arrows to change the value. Once finished, hold the **C** button for 3 seconds and your adjustment will save.

Should a value inputted not fall within the specified range of the device being modified, the value will automatically adjust to the highest possible value. A description of each device setting is:

- **DM0:** Timer value for Direction 1. The range of this setting is 1 – 60 seconds. This is how long the direction will remain open for if a user does not pass through the direction. The default setting is 7 seconds.
- **DM1:** Timer value for Direction 2. The range of this setting is 1 – 60 seconds. This is how long the direction will remain open for if a user does not pass through the direction. The default setting is 7 seconds.
- **DM2:** Direction 1 fail status. This determines when the solenoid receives power and is preconfigured based on each individual order. 0 means the direction is fail lock & 1 means the direction is fail open. This setting is not affected by factory reset.
- **DM3:** Direction 2 fail status. This determines when the solenoid receives power and is preconfigured based on each individual order. 0 means the direction is fail lock & 1 means the direction is fail open. This setting is not affected by factory reset.
- **DM4:** Direction 1 one-shot timer: This setting determines whether or not the access control input length is ignored and converted to a .1 second pulse internally. Enabling this allows the turnstile to ignore access control from allowing too many users pass through the turnstile. Disabling it allows access control to hold the direction open. 0 means the one-shot timer is inactive & 1 means the one-shot timer is active.
- **DM5:** Direction 2 one-shot timer: This setting determines whether or not the access control input length is ignored and converted to a .1 second pulse internally. Enabling this allows the turnstile to ignore access control from allowing too many users pass through the turnstile. Disabling it allows access control to hold the direction open. 0 means the one-shot timer is inactive & 1 means the one-shot timer is active.
- **DM6:** Direction 1 multi-swipe: This setting allows more than one access control request to be processed at a time to allow a faster flow of traffic. The range is 1-3. As each access control request is processed, each rotation subtracts from the total, allowing a constant flow of traffic. Most installations would benefit from a value of 2, which is the default setting.
- **DM7:** Direction 2 multi-swipe: This setting allows more than one access control request to be processed at a time to allow a faster flow of traffic. The range is 1-3. As each access control request is processed, each rotation subtracts from the total, allowing a constant flow of traffic. Most installations would benefit from a value of 2, which is the default setting.

- **DM9:** Direction 1 Count: Displays how many valid rotations were made in direction 1. This has a max value of 60,000 and will reset to 0 once that number is reached. This will not count fire alarm, hold open or key override rotations. This count is for maintenance and repair logging purposes.
- **DM10:** Direction 2 Count: Displays how many valid rotations were made in direction 2. This has a max value of 60,000 and will reset to 0 once that number is reached. This will not count fire alarm, hold open or key override rotations. This count is for maintenance and repair logging purposes.

Additionally, scrolling downward past DM0 will allow you access to **DM1999**, which resets all settings to factory defaults (except for solenoid fail status settings). Choose any value greater than 0 to perform the factory reset.

6500 Series Full Height Control Head Limit Switches

Limit Switch Information

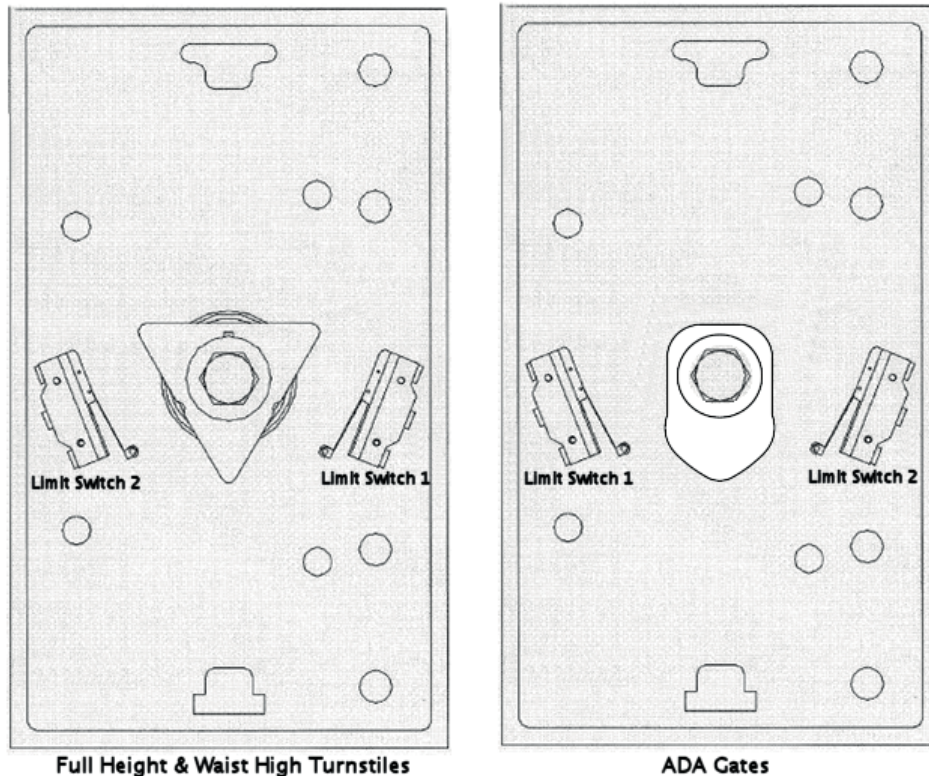

Note: When replacing a switch, be sure to utilize the normally open and common screw terminals. Normally open should go into the PLC's Limit Inputs and Common should go to 24VDC+

Direction 1 is canceled by limit switch 1 and direction 2 is canceled by limit switch 2. As the unit rotates, both limit switches are triggered. However, only the limit switch designated for that direction is utilized to relock the unit. The switch is triggered towards the end of the rotation. Once it is triggered, the locking mechanism returns to the locked position, but users may still proceed until the home position is reached.

A minor exception to this is in the case of an ADA swing gate. The limit switch is triggered towards the beginning of the swing, which allows the locking bar to prevent the gate from over swinging. In this instance, the limit switches are designated backwards from those on a standard turnstile. Refer to the above diagram to illustrate which is which.



Note: The control head will not operate properly if the limit switches and top cam are not adjusted properly or altered from factory shipment.

6500 Series Control Head & Turnstile Maintenance & Cleaning

To ensure long life on any turnstile, the following maintenance is recommended.

- Annual
 - If you have a full height turnstile: On the bottom of each rotor, you should find a grease fitting. Utilize this fitting to re-grease the bearing that the rotor rests on.
 - Make sure all nuts are securely fastened on all parts of the turnstile.
 - On the control head, remove the index pin and apply white lithium grease. Use 3 in 1 oil on the index pin roller. The index pin is easily removed from the control head by disconnecting the springs from it.
- Bi-annual
 - Remove the lid from the control head. Clean any debris and apply grease to the shock roller assembly. Use 3 in 1 oil on the shock piston roller.
 - Apply 3 in 1 oil to the bronze bushing on the locking bars.
 - Inspect control head parts for wear and tear, replace parts as needed.
 - Reassemble control head. Using a removable strength (blue) thread sealer (such as Loctite) on the head bolts will help the control head remain sturdy.
- Cleaning
 - Galvanized turnstiles can be cleaned with soap and water. Galvanized finish may fade in color over time, but this is normal.
 - Powder coated turnstiles should be cleaned with a non-abrasive cleanser such as Formula 409. Be sure to inspect for chips on the powder coating and touch them up, or the exposed steel may rust.
 - Stainless steel turnstiles should be polished with a stainless steel wax or polish. **In harsh environments, such as facilities near the ocean or within a chemical plant, stainless steel turnstiles should be waxed with a simple car wax to prevent surface discoloration on an annual basis.** Discoloration and surface rust can be easily removed with a rust penetrating product, such as P.B. Blaster, along with non-scratching scouring pads.

Control heads can be removed from the turnstile and shipped to the factory at any time for repairs and maintenance. Please include contact information so we can call to discuss any issues your control head may have. Please note that any repairs that cost under \$500.00 will require a credit card payment.



Note: The recommended time frames are assuming a maximum of 75000 passages per year. Turnstiles with heavier traffic should be maintained more frequently.

6500 Series Control Head Testing

6500 Series Testing Procedures

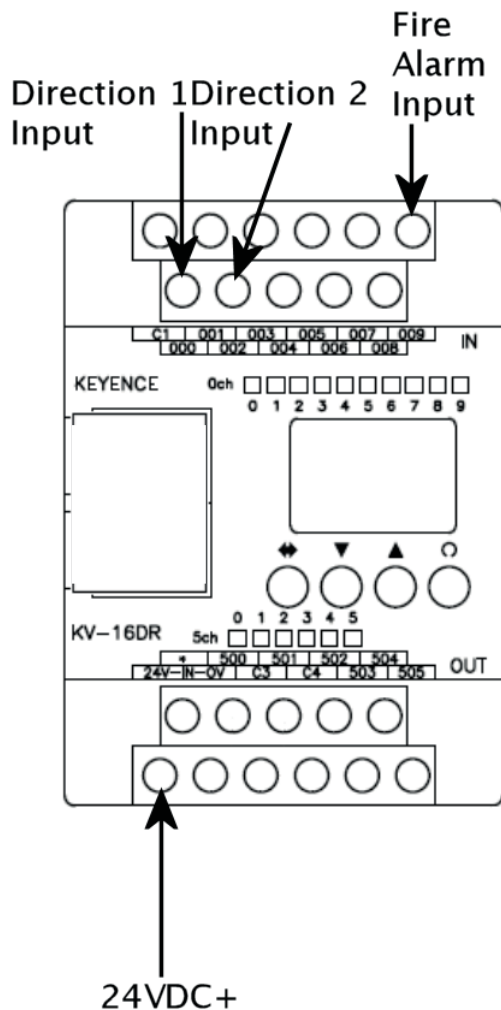

To test whether or not your control head is functioning properly...

- Unplug power supply from outlet
- Disconnect access control and fire alarm system from inputs 000, 002, and 009 (if applicable)
- Plug the power supply back into the outlet
- Using a length of 18 gauge wire, momentarily touch the the 24VDC+ screw terminal with one end, and input 000 with the other. The solenoid should engage
- Trigger limit switch 1 and the unit should relock. It will also relock when the timer expires
- Repeat this step with 24VDC+ and input 002. The alternate solenoid should engage
- Trigger limit switch 2 and the unit should relock
- If desired, test the fire alarm by jumping and holding input 009 to 24VDC+ and both directions should unlock

6500 Series Control Head Troubleshooting

Symptom	Cause	Solution
Turnstile does not unlock.	Power supply is not receiving input voltage.	Verify outlet receptacle installed in mainframe is operating correctly and that the power supply is plugged in.
	Loose wiring from power supply to logic controller.	Refer to pages 16-18 for wiring information.
	Power supply is not producing voltage.	Check output voltage from power supply. It should be 24VDC.
	Logic controller program is not running. This can be determined by the color of the lettering on the logic controller display screen. If it is red, it is not running.	Refer to the "Overview of the Access Window" section on page 19 and "run" the program.
	Access control device malfunction.	Disconnect access control from circuit board. Momentarily jump directional inputs. If the turnstile works properly, contact manufacturer of access control device.
	Control head requiring maintenance.	Refer to page 24.
More than one person can get through turnstile.	Access control device output set too long.	This can be avoided by enabling the one-shot timers built into the logic controller program. If this is undesirable, ensure the output from the access control system is 1 second or less.
	Loose wiring to the logic controller from limit switches.	Refer to pages 16-18 for wiring information.
	Limit switches are broken.	Inspect limit switches for breakage, replace as needed.
	Limit switches are missing the triangular top cam.	Adjust the top cam to the proper height and or tweak the triggers on the limit switch. Refer to page 23 for information.
Unable to hold direction open to allow multiple people to pass through the turnstile.	One-shot timers are enabled.	Disable the one shot timer settings on the logic controller. Be sure that your access control output is one second or less during regular secure operation or extra people may be able to pass through.

Turnstile only rotates 30 degrees.	Limit switches wired incorrectly.	Refer to pages 16-18 for wiring information and page 23 for limit switch placement.
	Top cam is misaligned.	The top cam should have one point facing the control board. If this is not the case, readjust the top cam. Refer to page 23 for top cam information.
Unit remains unlocked until access control is presented.	Fail open / fail lock configuration is wrong.	Change fail open / fail lock mode on each direction as appropriate.
Turnstile is slamming into the closed position.	Shock either needs adjusted or replaced.	Refer to page 15 for more information.
Turnstile is not centering properly.	Shock needs adjusted.	Refer to page 15 for more information.
	Binding in control head.	See next troubleshooting hint.
Turnstile seems to be binding mechanically.	Rotor is not plumb / turnstile body is not level.	Level out the turnstile with shims
	Control head requires maintenance.	Refer to page 24 for more information.
Turnstile rotating the wrong direction.	Improperly filled out direction sheet.	In some cases, the control head can be reconfigured in the field to operate as needed. Refer to pages 9-14 for information about how the control head operates. If needed, control heads can be returned to the factory for reconfiguration for a fee of labor plus parts (if required). Please contact us before returning a control head in this instance.
	Directional inputs wired incorrectly.	Refer to wiring legend for direction port explanations on page 18
Turnstile fails lock when needed to fail open or vice versa.	Improperly filled out direction sheet.	Refer to page 14 for more information. Additional parts will be required to convert operation. The control head can be returned for reconfiguration for a fee of labor plus parts (if required). Please contact us before returning a control head in this instance.
Other problems.		Please contact us for any other issues.

Proper Turnstile Usage

The 6500 series turnstile control head is easy to use. There are a few things that users should be trained on and informed of.

- In the case of an electronic turnstile, approach the unit and swipe the card. Do not push on the arms of the rotor until after access control device is engaged and a click sound from the mainframe is heard. This sound is the locking mechanism engaging.



Note: Turnstile will not unlock if pressure is being applied to the rotor. The unit will unlock after pressure is released; however, it is a better practice to wait until the click sound is heard before pushing the rotor.

- After requesting access with access control devices, proceed through turnstile immediately. Waiting too long could cause the turnstile to time-out mid rotation, forcing the user to back out of the turnstile. Factory timer settings are at 7 seconds. While these timers are adjustable for up to 60 seconds, we recommend 7-10 seconds because if someone chooses to swipe and walk away from the turnstile, another person would not be able to pass through without credentials. The limit switches on the control head override the directional timers.
- Walk at a reasonable pace through the turnstile. Do not slam the rotor through the rotation. This can be unsafe and may cause unnecessary wear and tear to the control head.
- Try to be respectful of users wanting to pass through the other direction. Allow people who are waiting an opportunity to pass through the turnstile.
- Avoid rotating the rotor on a full height before walking through on a valid entry request. This will cause the rotor to lock before you have a chance to pass through the turnstile.
- Piggybacking: More than one user trying to squeeze through the turnstile on one rotation should be avoided. Large bags and carts should be brought through an alternate means of entrance.



Warranty Information

Seller warrants the goods against defective workmanship and materials provided that Buyer notify Seller within one (1) year after receipt by Buyer of the goods of any claim under this Warranty. The liability of Seller shall be limited to replacing or repairing defective goods returned by Buyer and delivered to the factory of the Seller, transportation charges prepaid.

Replaced or repaired goods will be redelivered freight repaid to the address of Buyer shown hereon. Except for the Warranty contained herein, there shall be no other warranties, such as warranties of fitness and merchantability or otherwise express or implied, written or verbal, and Seller shall not be liable for consequential damages in any event.

Compact Switching Power Supply MS2 Series Instruction Manual

Part Names and Functions

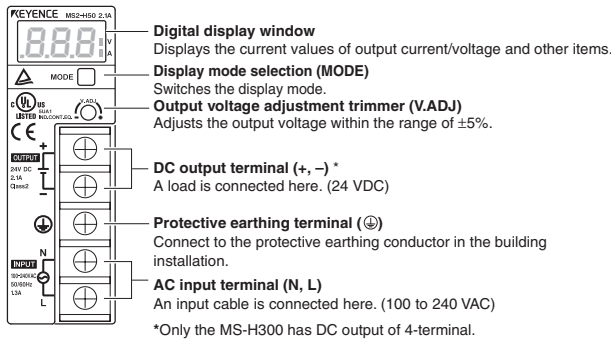

Safety Precautions



- Do not perform any electrical wiring while electric current is applied. Failure to follow this may result in an electric shock or fire.
- Be sure to connect the grounding cable. Failure to follow this may result in an electric shock or fire.
- Do not touch this unit within 1 minute after AC input is turned off. Failure to follow this may result in an electric shock.
- Do not modify or repair this unit. Failure to follow this may result in an electric shock, accident, or product failure.
- Do not touch any terminal of this unit while electric current is applied. Use the unit with the terminal cover installed to avoid an electric shock.

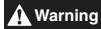

- When this unit is used in a system that may cause a serious accident or damage if the unit fails, be sure to install a safety device.
- Pay attention to prevent foreign matter such as metal particles, dust, paper or wood chips from entering the inside of this unit. Failure to follow this may result in a fire or product failure.
- Do not touch any metallic part while electric current is applied or immediately after input is shut off. Failure to follow this may result in a burn due to a high temperature.
- If a failure or abnormality occurs while this unit is in use, immediately such off AC input and stop operation of this unit. Failure to follow this may result in a fire or accident.



- Check that the AC input rated voltage of this unit is equal to the voltage of the AC power supply.
- Do not connect the AC power supply to the DC output terminals.
- Do not disturb the convection of air near the vent of the casing.

Precautions for CE Markings

KEYENCE has evaluated the conformity of the MS2 Series with the requirements of the EMC Directives and Low-voltage Directives under the following condition, and confirmed that the MS2 Series meets these requirements. For the Low-voltage Directives, the MS2 Series has obtained certification from TUV Rheinland for the following standards.

<Precautions>

● EMC Directives (89/336/EEC)

- Applicable standard (EMI) EN55011, Group 1, Class A
- Applicable standard (EMS) EN61000-6-2

● Low-voltage Directives (73/23/EEC)

- Applicable standard EN60950-1
- EN50178
- Overvoltage category II
- Pollution degree 2

- The MS2 Series is designed as a Class I Equipment. Be sure to connect the protective earthing terminal on the terminal block to the protective earthing conductor in the building installation.
- The MS2 Series is an open-type device. Be sure to install it in an appropriate enclosure rated as IP54 or better.
- Use the MS2 Series according to the derating conditions and the installation conditions described in this manual.
- The MS2 Series does not include a disconnecting device. Be sure to install a disconnecting device such as a circuit breaker in the building installation wiring.

Precautions for UL Standards

The MS2 Series meets the following UL standards and has obtained UL and C-UL certification.

- Applicable standard UL508 Industrial Control Equipment
UL60950-1 Information Technology Equipment - Safety
CAN/CSA C22.2 No. 14-M95 Industrial Control Equipment
CAN/CSA C22.2 No. 60950-1-03 Information Technology Equipment - Safety
- UL File No. E195940, E242533
- UL category NMTR, NMTR7 / QQQQ2, QQQQ8

<Precautions>

- Use wires that meet the following conditions for the terminal block.
(tightening torque : 1.2 N·m)

Wire range	AWG#14-22
Wire Material	Copper wire only
Wire type	Stranded wire only
Temperature rating	60°C/75°C
- The MS2 Series is designed as a Class I Equipment. Be sure to connect the protective earthing terminal on the terminal block to the protective earthing conductor in the building installation.
- The MS2 Series is an open-type device. Be sure to install it in an appropriate enclosure rated as IP54 or better.
- Use the MS2 Series according to the derating conditions and the installation conditions described in this manual.
- The MS2 Series does not include a disconnecting device. Be sure to install a disconnecting device such as a circuit breaker in the building installation wiring.
- The output of the MS2-H50 is regarded as Class 2 output specified in NEPA70 (NEC: National Electrical Code) in the U.S.A. (UL Category: EPBU2/EPBU8)

Installation Conditions

Installation environment

- Installation this unit indoors.
- Do not install this unit in locations exposed to direct sunlight.
- Do not install this unit in locations in which there is corrosive gas or flammable gas.
- Do not install this unit in locations exposed to a lot of dust, soot, or stem.
- Do not install this unit in locations in which water, oil, or chemicals may splash onto the unit.
- When installing this unit in a location subject to vibration or impact, consider the vibration proof mounting.

When installing this unit in a control console

- The ambient temperature for this unit should not exceed the upper temperature limit (refer to the derating characteristic). When the upper temperature limit may be exceeded, install a cooling fan or cooler so that the ambient temperature is below the upper temperature limit.
- Leave a sufficient ventilation space around this unit for head dissipation.
- Do not install this unit just above a device with high head generation (transformer, inverter, servo amplifier, etc.).

Installation

Space around the unit

The MS2 Series uses natural air-cooling. To ensure sufficient convection of air to dissipate heat, provide enough space between the MS2 Series and the control panel or other nearby devices as shown below.

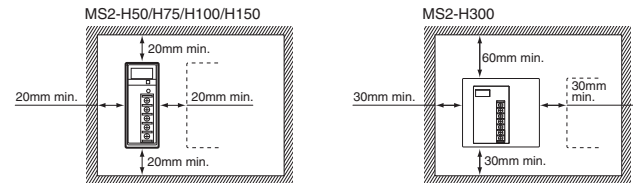

Installation orientation

Install this unit with the base (A) down as shown below. Do not install the unit in any other orientation.

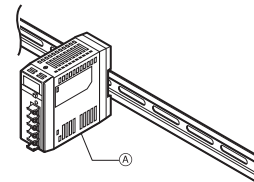

Mounting bracket (optional)

Make sure that the tightening torque for the mounting screw holes of this unit is 0.5 N·m or less.

Wiring

Terminals

Screw size	Tightening torque
M4	1.2 N·m

Crimp terminals



Cables

Select cables with a wire diameter suited to the output rated current.

Method of Operation

The display mode changes each time when the MODE switch is pressed.

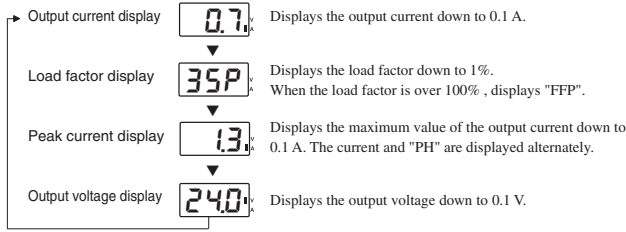

- The MS2 Series is set to the output current display mode before shipment. It retains the display mode that was used before the power was turned off.
- The maximum value for the peak current display mode is cleared when the power is turned off and the display mode is changed.
- When the switch is held down for 3 seconds or more, the current mode is locked and cannot be changed. To unlock the mode, hold down the switch again for 3 seconds or more.

Dimensions

Model	MS2-H50	MS2-H75	MS2-H100	MS2-H150	MS2-H300
Rated input voltage *1	100 to 240 VAC (85 to 284 VAC, 110 to 370 VDC)				
Rated Frequency *1	50/60 Hz (47 to 63 Hz, DC)				
Input current (100/200 VAC)	1.3 A/0.7 A max.	1.9 A/0.9 A max.	2.1 A/1.1 A max.	2.2 A/1.1 A max.	3.9 A/1.8 A max.
Efficiency (100/200 VAC)	82~95% typ. (with 100% load)				
Leakage current (100/200 VAC)	0.4 mA/0.75 mA max. (with 100% load)				
Rush current (100/200 VAC)	25 A/50 A max. (with 100% load, at 25°C cold start)			18 A/36 A max.	
Rated output voltage	24 VDC				
Adjustable voltage range	±5% (with V ADJ.)				
Rated output current	2.1 A (Class2)	3.2 A	4.5 A	6.5 A	12.5 A
Ripple/noise voltage	180mVp-p max.				
Input fluctuation	0.4 % max.				
Load fluctuation	1.5 % max.				
Temperature fluctuation	0.02 %/°C max.				
Starting time	500 ms max. (at Surrounding Air Temperature of 0 to 55°C under rated I/O conditions)				
Output holding time	20 ms min. (at Surrounding Air Temperature of 25°C under rated I/O conditions)				
Overcurrent protection	Activates when the current reaches 125% or more of the rated output current. Constant current voltage limiting. Automatic reset				
	2.7 A min.	4.0 A min.	5.3 A min.	7.9 A min.	15.6 A min.
Overvoltage protection *2	Activates when the voltage reaches 26.4 V or more. Voltage turn-off. Operation resumes when the input power is turned on again.				
Display method	3-digit, 7-segment LED (Character height: 10 mm)				
Memory backup time	Approx. 10 years (at 20°C)				
Display resolution	0.1 A/0.1 V/1%				
Surrounding Air Temperature (for operation)	-10 to 55°C, No condensation (See "Output Derating Characteristics".)				
Relative humidity	25 to 85%, No condensation				
Surrounding Air Temperature (for storage)	-20 to 70°C, No condensation				
Withstand voltage	3.0 kVAC 50/60 Hz 1 min (across input and output terminals), 2.0 kVAC 50/60 Hz 1 min (across input terminals and PE terminal), 500 VAC 50/60 Hz 1 min (across output terminals and PE terminal)				
Shock	Peak acceleration: 300 m/s ² in X, Y, and Z directions, 2 times respectively				
Vibration	In X, Y, and Z directions, 2 hours respectively under the following conditions 10 to 57 Hz, 0.3 mm double-amplitude, 57 to 500 Hz, 19.6 m/s ² (2G), 5.5-minute cycle				
Insulation resistance	100 MΩ min. (with 500 VDC megohmmeter) (across input and output terminals) (across input terminals and PE terminal) (across output terminals and PE terminal)				
Safety standard	UL : UL508, UL60950-1 C-UL : CSA C22.2 No.14-M95, CSA C22.2 No.60950-1-03 IEC : EN60950-1, EN50178 EN : IEC60950-1				
EMC standard	FCC Part15B ClassA, EN55011 ClassA, EN61000-6-2				
Limits for harmonic current emissions	EN61000-3-2 *3				
Parallel operation	Possible (OP-42207 is required.) *4				
Serial operation	Possible (External diode is required.) *4				
Cooling method	Natural air-cooling				
Weight	Approx. 270g	Approx. 470g	Approx. 490g	Approx. 700g	Approx. 1540g

- *1 For conforming to safety standards shown above, rated input voltage is 100 to 240 VAC 50/60 Hz.
*2 To reset the unit, turn off the input power once, wait for 1 minute or more, and then turn on the input power again.
*3 For MS2-H100, it is applied only when the load ratio is 70% or lower.
*4 The Applicable standards do not apply for parallel and serial operations.

Output Derating Characteristics

MS2-H50/H150

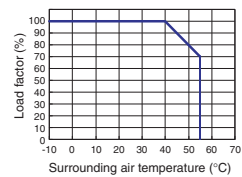

MS2-H75

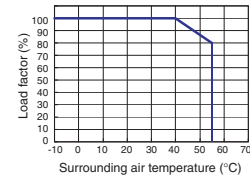

MS2-H100

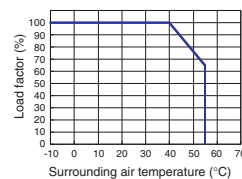

MS2-H300

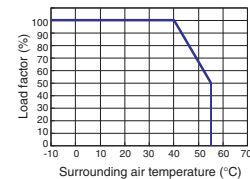

- * The characteristic data shown above are obtained when this unit is installed as described in this Manual.
* The surrounding air temperature is the temperature 50 mm below the bottom of the MS2 Series unit.

Dimensions

MS2-H50/H150

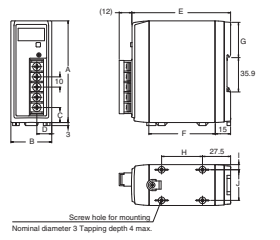

Model	A	B	C	D	E	F	G	H	I	J
MS2-H50	109.4	39.1	14.4	17.1	35.9	10.4	20	5	26	
MS2-H150	114.5	35	13.1	11.7	11.0	7.8	4.1	5.2	16.7	42.5

MS2-H150

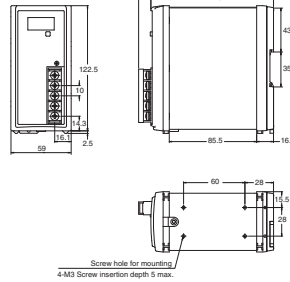

When bottom mounted

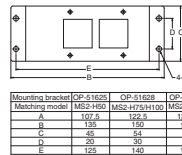
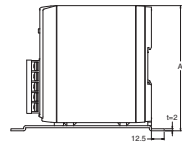

When side mounted

Mounting bracket	OP-51624	OP-51625	OP-42124
Matching model	MS2-H50	MS2-H75/H100	MS2-H150
A	107.5	122.5	132.5
B	38	39	39
C	35	34	35
D	32	32	32
E	11.5	12.5	12.5
H	15	15	15

Two holes only for OP-51625. The side mounting bracket can be attached to either sides.

MS2-H300

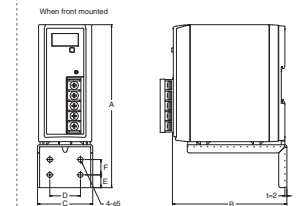
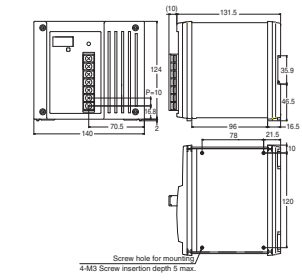

Mounting bracket	OP-51624	OP-51627	OP-42124
Matching model	MS2-H50	MS2-H75/H100	MS2-H150
A	163.4	169.4	173.5
B	38	38	38
C	35	35	35
D	32	32	32
E	11.5	12.5	12.5
H	15	15	15

Two holes only for OP-51624.

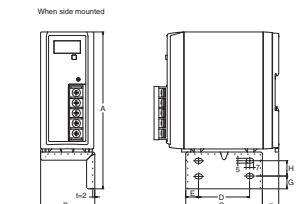

Mounting bracket	OP-51624	OP-51625
Matching model	MS2-H50	MS2-H75/H100
A	126.5	133.5
B	38	38
C	35	35
D	32	32
E	11.5	12.5
H	15	15

Two holes only for OP-51625. The side mounting bracket can be attached to either sides.

WARRANTIES (MUST ACCOMPANY THE PRODUCTS): KEYENCE, at its sole option, will refund, repair or replace at no charge any defective Products within 1 year from the date of shipment. Unless stated otherwise herein, the Products should not be used internally in humans, for human transportation, as safety devices or fail-safe systems. EXCEPT FOR THE FOREGOING, ALL EXPRESS, IMPLIED AND STATUTORY WARRANTIES, INCLUDING WARRANTIES OF MERCHANTABILITY, FITNESS FOR A PARTICULAR PURPOSE AND NON-INFRINGEMENT OF PROPRIETARY RIGHTS, ARE EXPRESSLY DISCLAIMED. KEYENCE SHALL NOT BE LIABLE FOR ANY DIRECT, INDIRECT, INCIDENTAL, CONSEQUENTIAL OR OTHER DAMAGES, EVEN IF DAMAGES RESULT FROM THE USE OF THE PRODUCTS IN ACCORDANCE WITH ANY SUGGESTIONS OR INFORMATION PROVIDED BY KEYENCE. In some jurisdictions, some of the foregoing warranty disclaimers or damage limitations may not apply.



KEYENCE CORPORATION

1-3-14, Higashi-Nakajima, Higashi-Yodogawa-ku,
Osaka, 533-8555, Japan
Phone: 81-6-6379-2211 Fax: 81-6-6379-2131

AFFILIATED COMPANIES

KEYENCE CORPORATION OF AMERICA

Phone: 201-930-0100 Fax: 201-930-0099

KEYENCE DEUTSCHLAND GmbH

Phone: 06102-36 89-0 Fax: 06102-36 89-100

KEYENCE (UK) LIMITED

Phone: 01908-696900 Fax: 01908-696777

KEYENCE FRANCE S.A.

Phone: 01 56 37 78 00 Fax: 01 56 37 78 01

KEYENCE ITALIA S.p.A.

Phone: 02-6688220 Fax: 02-66825099

KEYENCE SINGAPORE PTE LTD.

Phone: 6392-1011 Fax: 6392-5055

KEYENCE (MALAYSIA) SDN BHD

Phone: 03-2092-2211 Fax: 03-2092-2131

KEYENCE (THAILAND) CO., LTD.

Phone: 02-369-2777 Fax: 02-369-2775

KEYENCE TAIWAN CO., LTD.

Phone: 02-2718-8700 Fax: 02-2718-8711

KEYENCE (HONG KONG) CO., LTD.

Phone: 3104-1010 Fax: 3104-1080

KEYENCE INTERNATIONAL TRADING (SHANGHAI) CO., LTD.

Phone: 021-68757500 Fax: 021-68757550

KOREA KEYENCE CO., LTD.

Phone: 02-563-1270 Fax: 02-563-1271

Specifications are subject to change without notice.

B0124

© KEYENCE CORPORATION, 2004
0086 [96M1274] Printed in Japan



PLC Specifications

General specifications

Model	AC type		DC type		
	KV-10AT(P)/AR	KV-16AT(P)/AR KV-24AT(P)/AR KV-40AT(P)/AR	KV-10DT(P)/DR	KV-16DT(P)/DR KV-24DT(P)/DR KV-40DT(P)/DR	
Rated voltage	100 to 240 VAC (±10%)		24 VDC (+10%, -20%)		
AC current consumption	KV-10AT(P)/AR: 0.4 A KV-16AT(P)/AR: 0.5 A KV-24AT(P)/AR: 0.6 A KV-40AT(P)/AR: 0.7 A		—		
AC power factor	60%		—		
Output voltage	24 VDC (±10%)		—		
Output capacity <small>(Including the internal current consumption and current consumption of expansion units.)</small>	KV-10AT(P)/AR: 0.4 A KV-16AT(P)/AR: 0.6 A KV-24AT(P)/AR: 0.6 A KV-40AT(P)/AR: 0.7 A		—		
Allowable instantaneous interruption time	40 ms max.		2 ms max.		
Internal current consumption (converted into 24 VDC value)	Base unit	KV-10AR/DR: 100 mA max. KV-10AT(P)/DT(P): 80(85) mA max. KV-16AR/DR: 120 mA max. KV-16AT(P)/DT(P): 90(100) mA max. KV-24AR/DR: 140 mA max. KV-24AT(P)/DT(P): 100(105) mA max. KV-40AR/DR: 180 mA max. KV-40AT(P)/DT(P): 120(130) mA max.		KV-E16X: 35 mA max. KV-E16T(P): 60(70) mA max. KV-E16R: 110 mA max. KV-E4XR: 45 mA max. KV-E4XT(P): 30 mA max.	
		Others	KV-D30 Operator interface panel: 60 mA max. KV-P3E Handheld programmer: 65 mA max.		
	Ambient temperature: 0 to 50°C, 0 to 45°C (KV-P3E)				
Relative humidity	35 to 85%				
Ambient storage temperature	-20 to +70°C				
Withstand voltage	1,500 VAC for 1 minute (Between power terminal and I/O terminals, and between external terminals and housing)				
Noise immunity	1,500 Vp-p min., pulse width: 1 μs, 50 ns (by noise simulator) Conforming to EN standard (EN61000-4-2/-3/-4/-6)				
Shock	150 m/s ² (15 G), working time: 11 ms, in X, Y and Z directions, 2 times respectively				
Vibration	10 to 55 Hz, 1.5 mm max. double amplitude in X, Y and Z directions, 2 hours respectively (1 G max. when attached to DIN rail)				
Insulation resistance	50 MΩ min. (Between power terminal and I/O terminals, and between external terminals and housing, measured with 500 VDC megohmmeter)				
Environmental restrictions	No excessive dust or corrosive gases				
Weight	KV-10AR: Approx. 250 g, KV-10AT(P): Approx. 240 g, KV-16AR: Approx. 300 g, KV-16AT(P): Approx. 280 g, KV-24AR: Approx. 350 g, KV-24AT(P): Approx. 330 g, KV-40AR: Approx. 450 g, KV-40AT(P): Approx. 410 g, KV-10DR: Approx. 150 g, KV-10DT(P): Approx. 140 g, KV-16DR: Approx. 190 g, KV-16DT(P): Approx. 180 g, KV-24DR: Approx. 240 g, KV-24DT(P): Approx. 210 g, KV-40DR: Approx. 330 g, KV-40DT(P): Approx. 280 g				

Performance specifications

Arithmetic operation control method	Stored program method	
I/O control method	Refresh method	
Programming language	Ladder diagram and expanded ladder diagram	
Instruction types	Basic instruction: 28, Application instruction: 22, Arithmetic instruction: 26, Interrupt instruction: 4	
Minimum scan time	140 μs min.	
Instruction processing time	Basic instruction: 0.7 μs min., Application instruction: 6.4 μs min.	
Program capacity	2,000 steps (KV-10xx, KV-16xx) 4,000 steps (KV-24xx, KV-40xx)	
Maximum number of expansion units	8 (7 for KV-40xx)	
Number of I/O points (including 10 to 40 I/O points of basic unit)	10 to 152 points (when expansion units are connected)	
Internal utility relay	2,560 points: 1000 to 1915 and 3000 to 17915	
Special utility relay	160 points: 2000 to 2915	
Data memory (16 bits)	2,000 words: DM 0000 to DM1999	
Temporary data memory (16 bits)	32 words: TM00 to TM31	
Timer/counter	250 in all: 0.1-s timer: TMR (0 to 6553.5 s), 0.01-s timer: TMH (0 to 655.35 s), 0.001-s timer: TMS (0 to 65.535 s), UP counter: C, Up/down counter: UDC	
Digital trimmer	2 trimmers (set in access window)	
High-speed counter	2 counters of 30 kHz, 2-phase high-speed counter (0 to 65535 count) *1	
High-speed counter comparator	4 comparators (2 for each high-speed counter) Direct output allowed	
Positioning control function	Independent 1 axis, 50 kHz max.	
Memory switch	16	
Memory backup	Program memory	Flash ROM, rewritable 100,000 times or more
	Data memory, counter, internal utility relay <small>(Retention devices are set by MEMSW instruction.)</small>	Data retained for 2 months min. with electrical double-layer capacitor (at 25°C), Data can be backed up with Flash ROM in all models.
Self-diagnosis	CPU and RAM errors	
Number of contact comments	1,000 max. contact comments can be saved.	

*1. 24-bit setting is available.

Input/output circuit of base unit

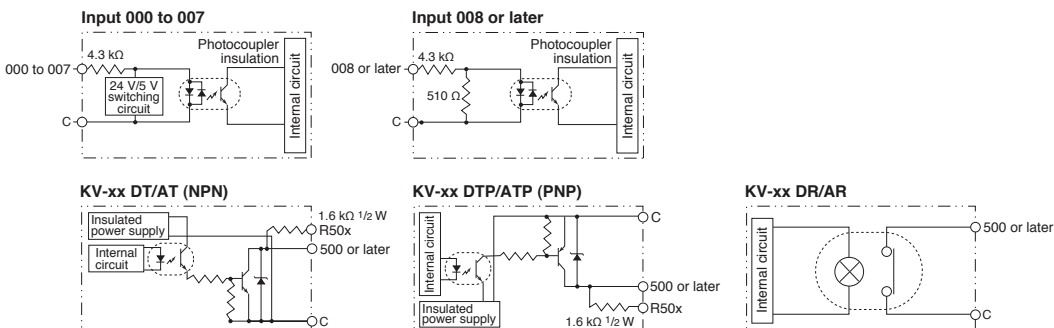

Input specifications of base unit

Model	KV-10xx	KV-16xx	KV-24xx	KV-40xx
No. of inputs	6	10	16	24
Input common	COM is connected internally.			
Maximum input rating	26.4 VDC			
Input voltage *1	24 VDC, 5.3 mA/5 VDC, 1.0 mA			
Input time constant	10 ms (Typical) 10 μs when HSP instruction is used Variable in 7 steps from 10 μs to 10 ms while special utility relay 2813 is ON (Set by DM1940)			
Interrupt input response	10 μs (Typical)			
High-speed counter input response	30 kHz (24V±10%)			

*1. Inputs 000 to 007 can be changed to 5 V input.

Output specifications of basic unit

Model	KV-10xT(P)	KV-16xT(P)	KV-24xT(P)	KV-40xT(P)	KV-10xR	KV-16xR	KV-24xR	KV-40xR
No. of outputs	4	6	8	16	4	6	8	16
Output common	1 common				Each common terminal is independent.			
Output type	Transistor output (NPN or PNP)				Relay output			
Rated load	30 VDC 0.3 A (503 and other) 0.1 A (500 to 502)				250 VAC/30 VDC 2 A (Inductive load) 4 A (Resistive load)			
Peak load current	0.2 A (500 to 502) 1 A (Other)				5 A			
Relay service life	—				Electrical service life: 100,000 times or more (20 times/min) Mechanical service life: 20-million times or more			
Relay replacement	—				Not allowed			
Output frequency	50 kHz (500 to 502)				—			
Built-in serial resistance	1.6 kΩ 1/2W (R500 to R502)				—			

Input/output specifications of expansion unit

Input/output	Input		Output				Input/output
External connection method	Terminal block						
Model	KV-E8X	KV-E16X	KV-E8T(P)	KV-E16T(P)	KV-E8R	KV-E16R	KV-E4XT(P)/R
Number of inputs	8	16	—	—	—	—	4
Input common	4 points/common		—	—	—	—	4 points/common
Maximum input rating	26.4 VDC		—	—	—	—	26.4 VDC
Input voltage	24 VDC, 5.3 mA		—	—	—	—	24 VDC, 5.3 mA
Minimum ON voltage	19 V		—	—	—	—	19 V
Maximum OFF current	2 mA		—	—	—	—	2 mA
Input impedance	4.3 kΩ		—	—	—	—	4.3 kΩ
Input time constant <small>(Changed in two steps by special utility relays 2609 to 2612)</small>	For both rising (OFF → ON) and falling (ON → OFF) operations, 10 ms: 10 ms±20%, 10 μs: 10 μs±20%		—	—	—	—	For both rising (OFF → ON) and falling (ON → OFF) operations, 10 ms: 10 ms±20%, 10 μs: 10 μs±20%
Number of outputs	—	—	8	16	8	16	4
Output type	—	—	NPN (PNP) Transistor		Relay		NPN (PNP) Transistor/Relay
Output common	—	—	COM is connected internally.		4 points/common		4 points/common
Rated load voltage	—	—	30 VDC		250 VAC/30 VDC, 2 A (Inductive load), 4 A (Resistive load)		30 VDC/ 250 VAC/30 VDC, 2 A (Inductive load), 4 A (Resistive load)
Rated output current	—	—	0.5 (0.3) A/point		2 A/point (Inductive load), 4 A/point (Resistive load), 4 A/common		0.5 A/point, 2 A/point (Inductive load), 4 A (Resistive load), 4 A/common
ON resistance	—	—	—		50 mΩ or less		— / 50 mΩ or less
Leakage current at OFF	—	—	100 μA max.		—		100 μA max./ —
Residual voltage at ON	—	—	0.8 V max.		—		0.8 V max./ —
Rising operation time (OFF → ON)	—	—	50 μs max.		10 ms max.		50 μs max./10 ms max.
Falling operation time (ON → OFF)	—	—	250 μs max.		10 ms max.		250 μs max./10 ms max.
Relay service life	—	—	—		Electrical: 100,000 times or more (20 times/min), Mechanical: 20-million times or more		Electrical: 100,000 times or more (20 times/min), Mechanical: 20-million times or more
Relay replacement	—	—	—		Not allowed		— /Not allowed
Weight	Approx. 100 g	Approx. 130 g	Approx. 100 g	Approx. 130 g	Approx. 130 g	Approx. 190 g	Approx. 100 g/Approx. 120 g

Input/output circuit of expansion unit

