

TURNSTILES.us.

SECURING THE U.S. and the GLOBE

PRODUCT MANUAL

catrax
master



INDEX

| | |
|---|-----------|
| 1 GUIDELINES | 3 |
| 2 INTRODUCTION | 3 |
| 3 CHARACTERISTICS | 3 |
| 3.1 CATRAX Master operating mechanisms | 5 |
| 4 CATRAX MASTER ASSEMBLY / INSTALLATION | 5 |
| 4.1 Visual inspection | 5 |
| 4.2 Preparing the installation site and installing the column | 6 |
| 4.3 Mounting of arms..... | 7 |
| 4.4 Access to the CATRAX Master after installation | 8 |
| 5 INSTALLATION/ASSEMBLY OF OPTIONAL ITEMS | 10 |
| 5.1 Rear closure kit | 10 |
| 5.2 Card collection and storage kit | 10 |
| 5.2.1 Connecting the card collection kit to the control board | 11 |
| 5.3 Operation pictogram kit | 12 |
| 5.4 Direction pictogram kit | 12 |
| 5.5 Mechanical counter | 12 |
| 5.6 Electronic counting kit | 13 |
| 5.7 Power supply..... | 15 |
| 5.8 Control board | 15 |
| 5.8.1 Inputs..... | 18 |
| 5.8.2 Outputs..... | 18 |
| 5.8.3 Control board configuration – DS1 | 20 |
| 5.8.4 Sample configurations | 21 |
| 5.8.5 Serial configuration | 21 |
| 5.9 Anti-panic drop-arm system | 22 |
| 5.9.1 Electrical connections | 23 |
| 5.9.2 Mounting of arms | 24 |
| 5.9.3 Maintenance tests..... | 24 |
| 6 MAINTENANCE | 25 |
| 6.1 Regular maintenance..... | 25 |
| 6.2 Troubleshooting..... | 26 |
| 7 TECHNICAL CHARACTERISTICS | 27 |
| 8 WARRANTY AND TECHNICAL ASSISTANCE | 30 |

1 GUIDELINES

- Read the instructions in this manual carefully before assembling and installing the CATRAX Master turnstile. This will extend the life of the product and enable you to make full use of all its features.
- This product was not designed for outdoor use in unprotected areas.
- Keep this manual for future reference.
- reserves the right to upgrade the characteristics of its products at any time in order to incorporate technological advancements.
- TURNSTILES reserves the right to change the information contained in this manual without notice.
- TURNSTILES does not provide any warranty related to the information contained in this manual. TURNSTILES cannot be held responsible for any errors this manual may contain or for any problems caused by its use.
- The information contained in this manual is protected by copyright laws.
- This manual may not be copied, photocopied or translated in its entirety or in part, in any kind of medium, without TURNSTILES' written permission.

2 INTRODUCTION

The CATRAX line of turnstiles was developed to be robust, reliable and attractive. Its rounded lines house a sturdy blocking mechanism designed for very low maintenance.

CATRAX Master serves all major access control technologies presently available, being acclaimed as the best turnstile option in the market.

This manual presents a detailed description of CATRAX Master operation and components. To find out about other TURNSTILES products, please visit our website at www.TURNSTILES.us.

3 CHARACTERISTICS

The CATRAX Master is a turnstile with three bidirectional arms finished and brushed stainless steel (AISI 304).



The structure of the CATRAX Master is available in two finishes: brushed stainless steel (AISI 304) or 1020 carbon steel with black epoxy powder coating. It features fully rounded corners and a smooth surface with no exposed screws, in addition to a reinforced internal structure and plenty of space for practically any access control solution. It also has room for a no-break power supply unit and a card collection box (not included).

In order to simplify maintenance and assembly, the column of the CATRAX Master has an internal U-shaped mounting rack with a standard set of holes for prompt mounting of electronic boards. Additional holes can be drilled by the customer to accommodate specific needs. For access to the mounting rack, use the keys that are provided with the turnstile. Removal and insertion of the rack are extremely easy.



The upper column panels are manufactured in high-impact engineering plastic with customizable stainless steel sheets. The plastic panels are available in green, burgundy, or black. Special color orders are available upon consultation.

The upper cover stainless steel plates are designed for easy configuration and low-cost customization. The plates can be easily punched to accommodate integrated options such as operation pictogram (top), direction pictogram (side), card collection kit, display, or a combination of the above.

The CATRAX Master is compatible with most currently available technologies. The following optional items can also be ordered: card collection kit, pictogram kit, mechanical counter, power supply, control board, and display. These options are described in greater detail in section 5 Installation/Assembly of optional items.

NOTE

For detailed information on the dimensions of CATRAX Master components, see section 7 Technical Characteristics, page 27.

3.1 CATRAX MASTER OPERATING MECHANISMS

The CATRAX Master features two operating mechanisms. The basic model (with no control board) employs a bidirectional rotation system with two 12 V electromagnets that activate the locks and two optical sensors that provide the electromagnets with information on turn completion and direction of turn.

An optional microprocessor-based control board is also available. In this case, an "enable turn" signal is sent. If this signal is recognized, the arm will turn from left to right or right to left, depending on the signal received. Once half the turn (60 degrees) is completed, a 400 ms return signal is emitted, informing the direction of turn. After this signal, the arm will not turn back

Depending on the turnstile's configuration and model, forcing the arm in the absence of an "enable turn" signal will activate an electromagnet that locks the arm. In this case, the equipment may also emit an audible alarm and/or display a red X on the upper panel display (models with pictogram indicators). A return signal will then be sent, indicating that the turnstile was forced and informing the direction of turn.

The following figure shows the mechanism and functioning of the CATRAX Master.

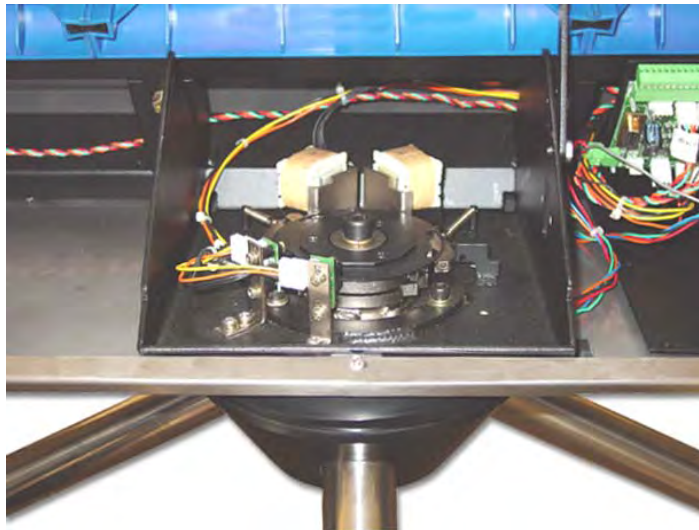

CAUTION

The specifications described above refer to optional items manufactured by TURNSTILES. Products from other manufacturers may also be installed on the CATRAX Master basic model.

4 CATRAX MASTER ASSEMBLY / INSTALLATION

4.1 VISUAL INSPECTION

The CATRAX Master may include a variety of items, depending on the customer's order. It is very important to carry out a careful visual inspection of the contents before beginning assembly and installation. Contents should be compared with the checklist provided with the package.

CAUTION

In order to prevent the loss of access keys, bolts and spanners used to assemble the CATRAX Master, these items are taped to the box containing the arms. Before disposing of any plastic or cardboard packaging materials, make sure that you have identified all the items in the checklist.

The figure below shows all the parts that may come with your CATRAX Master:

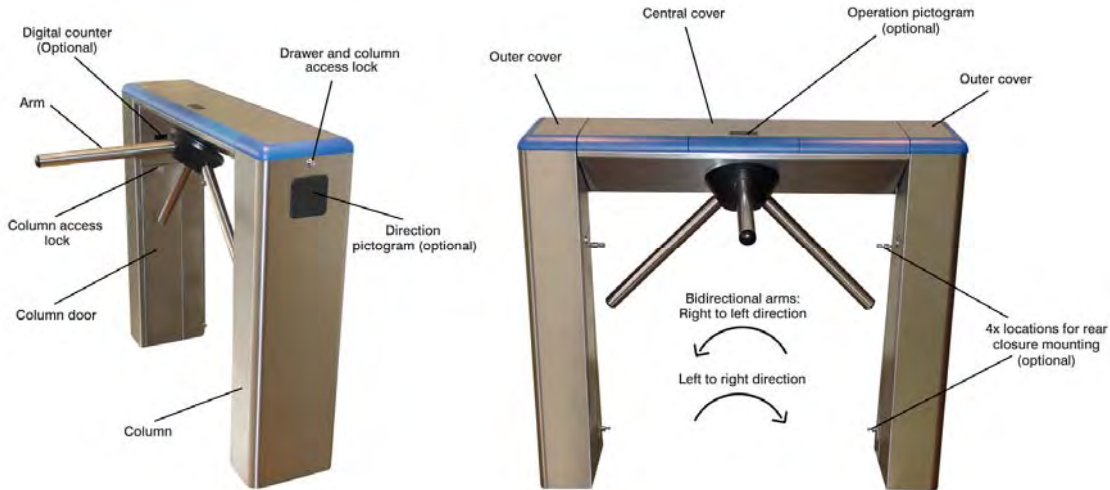

NOTE

In addition to the items indicated above, the CATRAX Master may include an optional power supply unit, control board, card collector and display.

4.2 PREPARING THE INSTALLATION SITE AND INSTALLING THE COLUMN

Before installing your CATRAX Master, please verify that:

1. The site chosen for installation is adequate.
2. There is an energy source or electric outlet close to where the turnstile will be installed, with appropriate conduits.
3. The chosen location is not exposed to the elements.
4. There is free access to the column access locks.
5. There is enough room for the arms to turn after the CATRAX Master is installed. For additional details concerning equipment dimensions, see item 7 Technical Characteristics, page 27.
6. The floor has the necessary support structure for anchor bolts (suggested minimum of 4 cm of FCK15 MPa concrete or equivalent).

CAUTION

As the installation of the CATRAX Master requires the floor to be drilled, the location must be selected with extreme care.

Product Manual

Once these precautions have been observed, proceed with the installation:

1. Drill the floor with a 3/8" bit and finish with a 12 mm or 1/2" bit. Drill two holes per column, according to the measurements shown in the following figure.

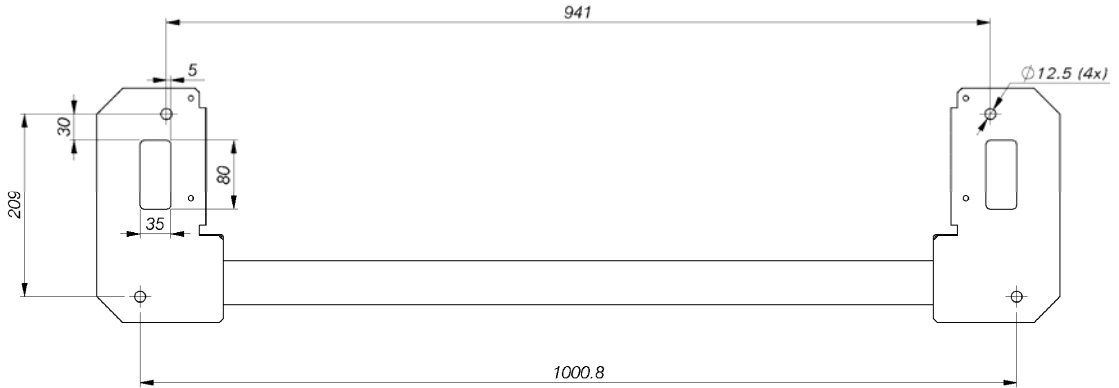

2. Clean the holes to remove drilling residue.

3. Place the external portion of the anchor bolts in the holes, leaving approximately 25 mm exposed.

NOTE

Recommended bolts: Tecart AF38110, 3/8x4".

4. Position the column and fasten it onto the floor with the anchor bolts. Use a 3/4" socket wrench or ratchet wrench.

4.3 MOUNTING OF ARMS

After installing the column, you may proceed with mounting the arms, as shown in the following figure.

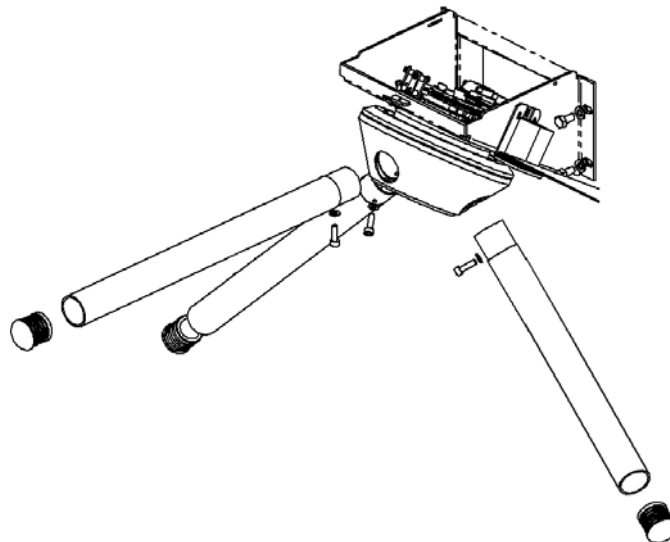

NOTES

- The bolt access cover is pressed into place.
- Use a #5 Allen wrench to mount the arms of the CATRAX Master.

4.4 ACCESS TO THE CATRAX MASTER AFTER INSTALLATION

After the CATRAX Master has been installed and assembled, access to internal components is possible via the rear cover, the front cover or the column door, using the access keys that come with the equipment.

Instructions for opening the CATRAX Master after installation:

1. Unlock the two extremities of the CATRAX Master, using the key supplied with the product. Remove the outer covers, which are merely pressed into place. The covers feature small internal lugs to keep them in place during operation, as can be seen in the photo, below right.

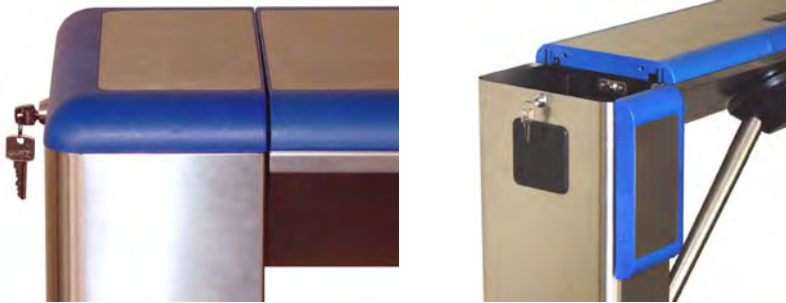

2. Before opening the central cover, deactivate the security pins located on each side of the cover.

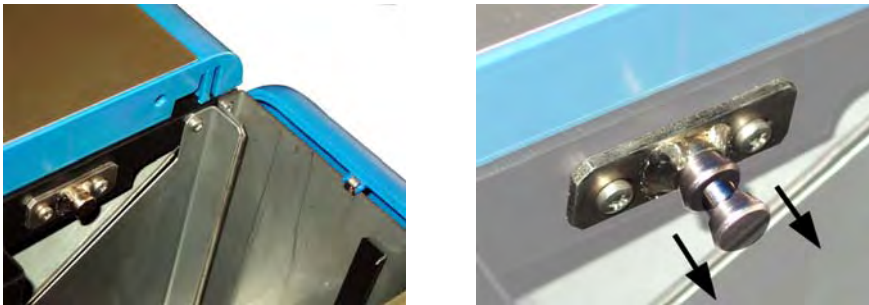

3. Open the cover according to the following figures:

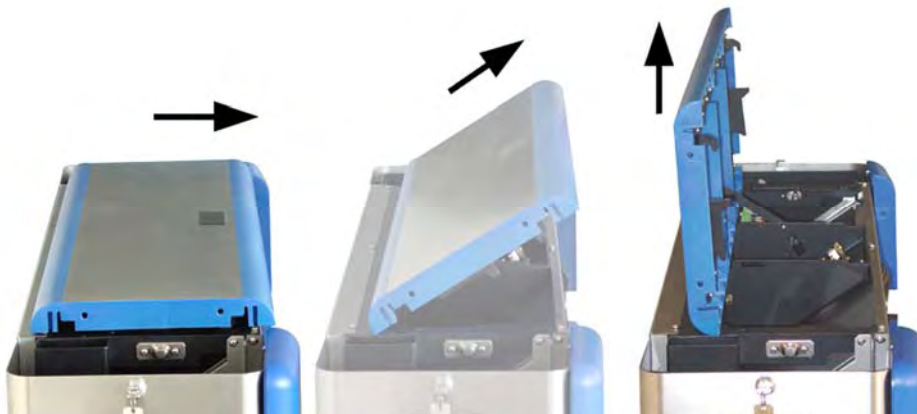

Product Manual

Note that the equipment structure contains a device that maintains the cover in the upright position (see detail).



4. The following figure shows the CATRAX Master with all covers open.



NOTE

To access the column door, remove the outer cover on the appropriate side.

5 INSTALLATION/ASSEMBLY OF OPTIONAL ITEMS

Although the CATRAX Master is compatible with the majority of available access control technologies, TURNSTILES offers several options to enhance access control and facilitate customization. These items are described below.

5.1 REAR CLOSURE KIT

The CATRAX Master can be supplied with a panel to close the rear space between the columns. The customer can choose between 6 mm tempered glass and 1.2 mm stainless steel. In addition to closing the rear space, the panel allows simple customization at low cost.

The rear closure kit is mounted at four locations on the columns, as shown below.

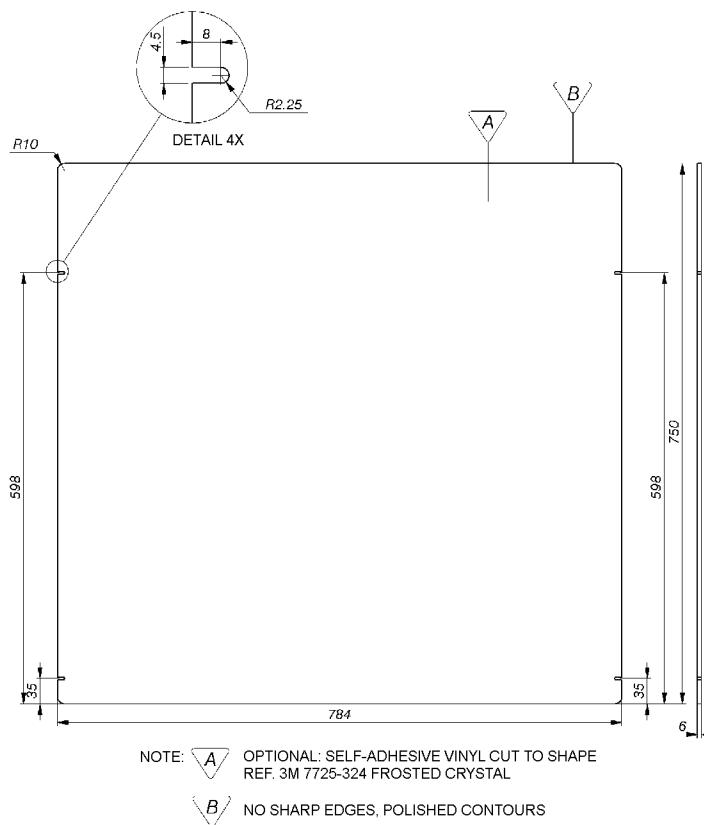

5.2 CARD COLLECTION AND STORAGE KIT

The collection kit with chute has a unit for card and badge collection, retention and storage, making it perfect for visitors or temporary users. The kit is composed of a plastic insertion slot, a solenoid-activated retention mechanism and a storage box. The following figure shows the items that come with the collection kit and serves as a guide for its assembly.



5.2.1 Connecting the card collection kit to the control board

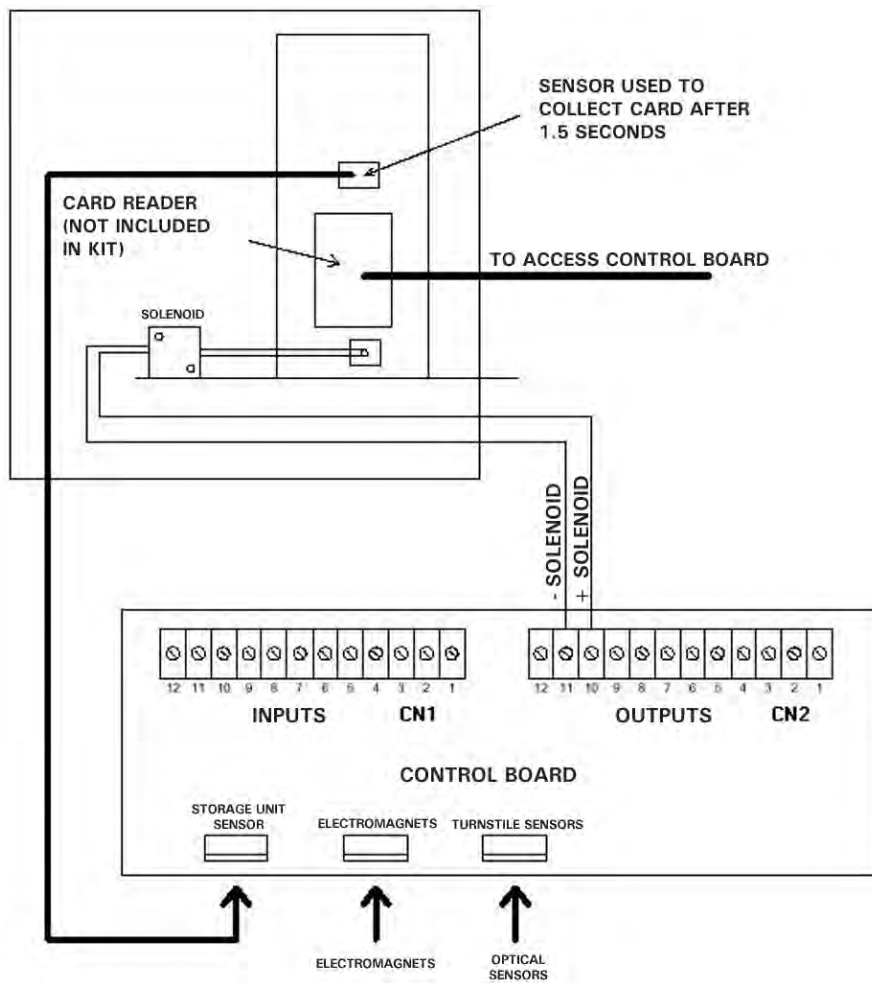

NOTES

- The storage box is part of the kit and is located below the collector unit. The electronic reader is not part of the kit.
- For further information on the configuration of the card collection kit , see item 5.7 Control board.

5.3 OPERATION PICTOGRAM KIT

The operation pictogram kit provides visual indication of the turn direction (green arrows) and turn locking (red X), on the upper part of the CATRAX Master.



NOTE

For further information on the configuration of the pictogram, see item 5.7 Control board.

CAUTION

The power supply has no ground connection. Grounding is directly through the turnstile housing, using the board mounting bolt.

5.4 DIRECTION PICTOGRAM KIT

The direction pictogram kit provides visual indication of the turn direction (green arrows) and turn locking (red X), on the front or side of the CATRAX Master.



NOTE

For further information on the configuration of the pictogram, see item 5.7 Control board.

5.5 MECHANICAL COUNTER

A five-digit mechanical counter is available as an optional item for your Catrax Master.

NOTE

For further information on the configuration of the counter, see item 7 Technical characteristics, on page 27 of this manual.

5.6 ELECTRONIC COUNTING KIT

The electronic pulse or rotation counting kit is digital, has six digits and has been developed for access control applications that employ Catrax Plus and Catrax Master turnstiles, and can also be employed in other projects that require this type of device. The counter is located in the same place (side slot) as the mechanical counter.

The electronic counter offers two sensor inputs allowing it to be configured for sequential sensing, making it possible to detect turnstile rotations in a given direction. The device is also capable of counting single pulses (in common with other counters available on the market).

The TURNSTILES electronic counter is operated by means of a single button that gives access to all of its functions. Optionally, an additional, key-operated button can be installed on the front panel.

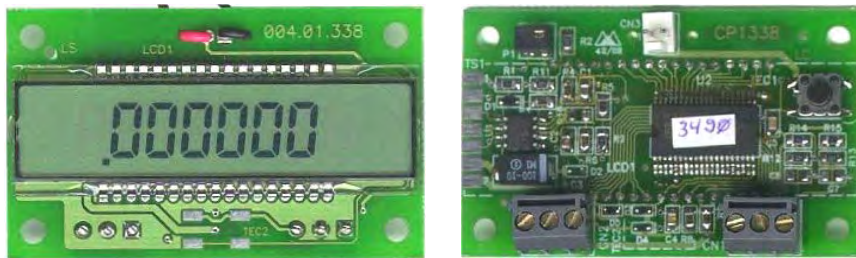

Available connections to the counter's circuit board are shown below.

| Signal | Name/Description |
|------------|---|
| CN1 | |
| 1 | Ground |
| 2 | Sensor 1 input |
| 3 | Sensor 2 input |
| CN2 | |
| 1 | External 5V power supply (battery eliminator) |
| 2 | Ground |
| 3 | Input for key switch to activate front panel button |
| CN3 | |
| 1 | Ground |
| 2 | 3V battery power supply (two 1.5V AA batteries) |

The device also offers two independent incremental count readouts, one of which indicates total count and the other partial count; only the second of these can be reset to zero during normal operation.

Pressing the control button for a short period switches the counting kit display between total and partial readouts. The readout being displayed is indicated by totAL or PARc on the screen and also by a dot in the bottom right corner for the partial readout and in the bottom left corner for the total.

View of the partial counter:

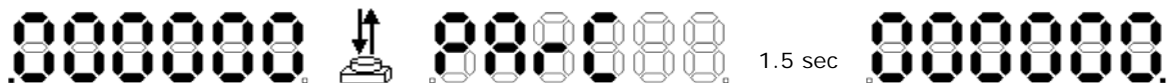

View of the total counter:



Product Manual

Resetting the partial readout to zero:

In order to reset the partial counter, the display must be in partial mode. Press and hold the function button for approximately 3 seconds (or until all digits display zero).

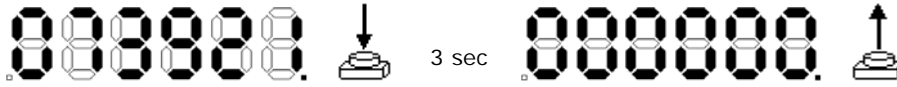

Configuration of operating mode:

The counter can be configured to count pulses on clockwise or counterclockwise rotations ("clockwise" and "counterclockwise" are used merely for the purpose of differentiating between the two rotation directions). The counter display must be in total mode for configuration. The procedure is shown below.

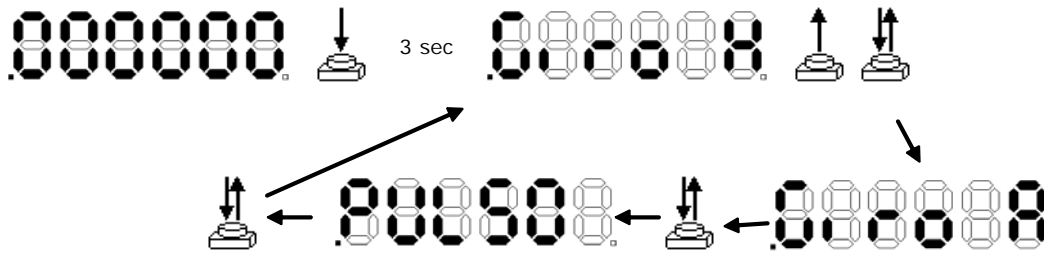

Sensors:

The sensors should short the sensor input to the counter's ground (keys, optical sensors, buttons, relays, etc.).

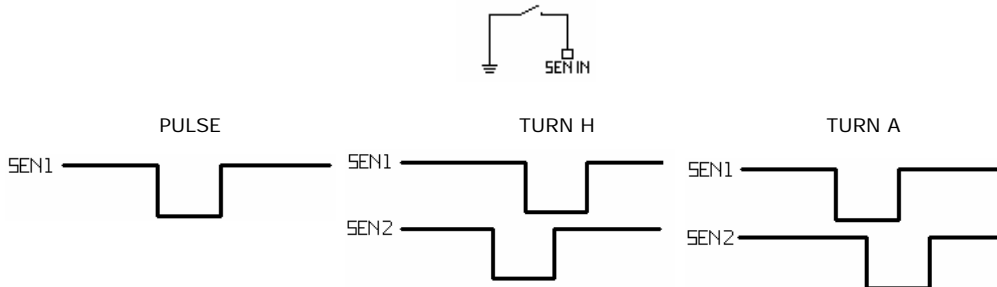

Power supply specifications:

| | |
|------------------------|--|
| Power supply | 2 AA batteries (3V) 5V (battery eliminator) |
| Battery life | 1.5 years or more than 3,000,000 cycles (alkaline batteries, with sensors and buttons open) |
| Number of digits | 6 |
| Data retention period | 1 min 30 sec (to allow batteries to be changed without losing count) |
| Size of display digits | 8 x 4 mm (height x width) |

External dimensions:

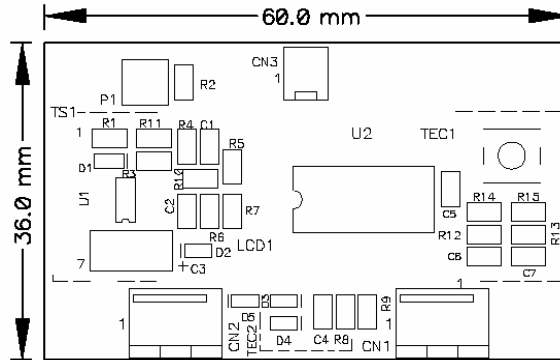

5.7 POWER SUPPLY

This power supply unit was especially designed for the CATRAX line. One of the main advantages of this optional item is its input voltage range – between 85 and 250 VAC – and therefore its capability to adapt to the voltage variations common in many installation sites.

This reliable power supply unit was carefully tested and developed to work under the most hostile environmental and temperature conditions. The power supply unit is also protected against short circuits and overheating.

Input (85 a 250 VAC)



NOTES

The power supply unit can be mounted on the rack provided with the CATRAX Master.

CAUTION

The power supply has no ground connection. Grounding is directly through the turnstile housing, using the board mounting bolt.

5.8 CONTROL BOARD

The CATRAX Master control board was designed to meet the needs of most current access control technologies. Its mechanical characteristics and layout are perfectly suited to the needs of the CATRAX Master, making it one of the best options for operating the equipment.

The following figures show the control board, straps, connectors and dip-switches, as well as the location of both the power supply and control board in the CATRAX Master.

Product Manual

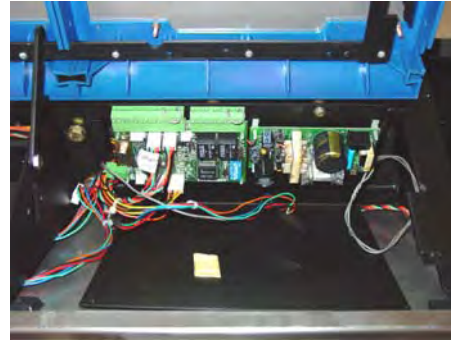
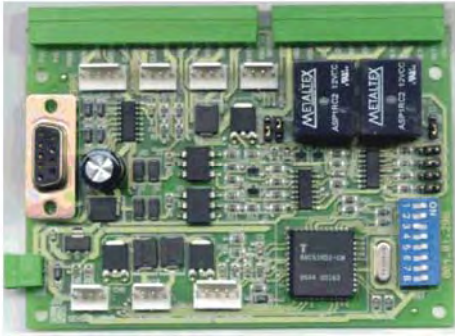

The table below describes the functions of controller board connectors.

| Signal | Name/Description |
|------------|---|
| CN1 | INPUTS |
| 1 | +Vext1 (enable turn by voltage) |
| 2 | HAB1 (enable turn by direct contact – right to left) |
| 3 | GND |
| 4 | Vext2 (enable turn by voltage) |
| 5 | HAB2 (enable turn by direct contact – left to right) |
| 6 | GND |
| 7 | +12 VDC (available for auxiliary – maximum of 500 mA) |
| 8 | CLOCK1 (input for reader left to right) |
| 9 | DATA1 (input for reader left to right) |
| 10 | CLOCK2 (input for reader right to left) |
| 11 | DATA2 (input for reader right to left) |
| 12 | GND |
| 13 | PROG1 (program direction) |
| 14 | PROG2 (program direction) |
| 15 | PIC1 (control front pictogram 1) |
| 16 | PIC2 (control front pictogram 2) |
| CN2 | OUTPUTS |
| 1 | N.O. or N.C. contact (HAB1 return) |
| 2 | C contact (HAB1 return) |
| 3 | N.O. or N.C. contact (HAB2 return) |
| 4 | C contact (HAB2 return) |
| 5 | Output for X (NPN open collector – maximum of 500 mA) – orange wire |
| 6 | Output for → (NPN open collector – maximum of 500 mA) – blue wire |
| 7 | Output for ← (NPN open collector – maximum of 500 mA) – green wire |
| 8 | +12VDC (power for indicator arrows) – red wire |
| 9 | GND (power for indicator arrows) – black wire |
| 10 | + badge collector box solenoid |
| 11 | - badge collector box solenoid |
| 12 | Audible signal (open collector - NPN) |
| CN3 | UPPER PICTOGRAM |
| 1 | +12 VDC (power for indicator arrows) – as for CN2[8] |
| 2 | Output for X (NPN open collector – maximum of 500 mA) – as for CN2[5] |
| 3 | Output for → (NPN open collector – maximum of 500 mA) – as for CN2[6] |
| 4 | Output for ← (NPN open collector – maximum of 500 mA) – as for CN2[7] |
| 5 | GND (power for indicator arrows) – as for CN2[9] |
| CN4 | SIDE PICTOGRAM 2 |
| 1 | +12 VDC (power for indicator arrows) |
| 2 | Output for X (NPN open collector – maximum of 500 mA) |
| 3 | Output for → (NPN open collector – maximum of 500 mA) |
| 4 | GND (power for indicator arrows) |
| CN5 | SIDE PICTOGRAM 1 |
| 1 | +12 VDC (power for indicator arrows) |
| 2 | Output for X (NPN open collector – maximum of 500 mA) |
| 3 | Output for → (NPN open collector – maximum of 500 mA) |
| 4 | GND (power for indicator arrows) |
| CN6 | INPUTS/OUTPUTS |
| 1 | Input or output 1 - configure at S4 (IN or OUT) |
| 2 | Input or output 2 - configure at S5 (IN or OUT) |
| 3 | Input or output 3 - configure at S6 (IN or OUT) |
| 4 | Input or output 4 - configure at S7 (IN or OUT) |

Product Manual

| Signal | Name/Description |
|-------------|----------------------------|
| CN7 | SERIAL RS-232 |
| 2 | TX |
| 3 | RX |
| 5 | GND |
| CN8 | POWER – POWER INPUT |
| 1 | +12 VDC Power input |
| 2 | GND Power input |
| CN9 | CARD STORAGE SENSOR |
| 1 | LED anode |
| 2 | Box signal |
| 3 | GND |
| 4 | GND |
| CN10 | ELECTROMAGNETS |
| 1 | + electromagnet 1 |
| 2 | - electromagnet 1 |
| 3 | + electromagnet 2 |
| 4 | - electromagnet 2 |
| CN11 | OPTICAL SENSORS |
| 1 | Sensor signal 1 |
| 2 | LED1 anode |
| 3 | Sensor signal 2 |
| 4 | GND |
| 5 | LED2 anode |

NOTES

- Side pictograms 2 and 1 refer to the devices located on each side of the equipment.
- The cables for the optical sensors (CN11) and electromagnets (CN10) are supplied together with the CATRAX Master.
- The cable for the storage box sensor (CN9) is supplied together with the card collection kit (optional).

The CATRAX Master can be configured as follows to determine direction of movement, using pins 13 and 14 of the CN1 connector:

| Direction of movement | PROG1 (pin 13) | PROG2 (pin 14) |
|----------------------------|----------------|----------------|
| Free in both directions | Open | Open |
| Blocked left to right only | GND | Open |
| Blocked right to left only | Open | GND |
| Blocked in both directions | GND | GND |

Pins 15 and 16, which control the side pictograms, should be configured as follows:

| PIC1 (pin 15) | PIC2 (pin 16) | Pictogram 1 | Pictogram 2 |
|---------------|---------------|-------------|-------------|
| Open | Open | ↗ | ↗ |
| Open | GND | ↗ | X |
| GND | Open | X | ↗ |
| GND | GND | X | X |

NOTE

PIC1 and PIC2 refer to the pictograms located on each side of the equipment.

The following sections deal with important aspects of CATRAX Master control board configuration and connections.

5.8.1 Inputs

The inputs or turn-enabling signals (HAB1 and HAB2) can be triggered by relay, pushbutton contact, or 5 to 24 VAC/DC or 110 to 220 VAC/DC pulses.

In order to enable turn through relay or pushbutton contact, make the connection as shown in the figure below:

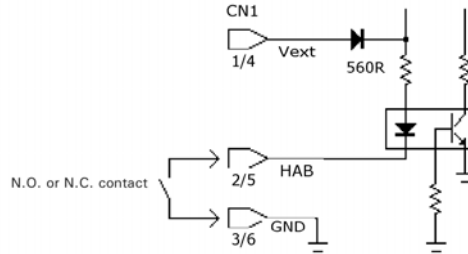

Turn-enabling through pulse is shown in the following figure. DC polarity must be observed. Use an external resistor for high voltages (110 to 220 V).

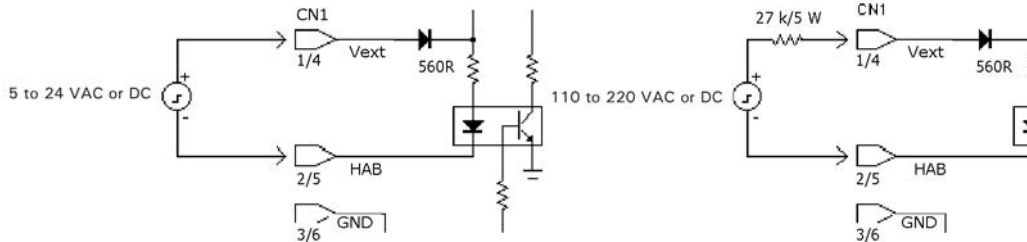

The control board also has inputs for optical sensors (CN6) that monitor turn without mechanical wear, and two opto-isolated inputs to release the CATRAX Master if required.

5.8.2 Outputs

The CATRAX Master board has outputs for return signals, electromagnets, pictogram indicators, card collection box, and audible alarm.

5.8.2.1 Return signals

The return signals indicate the moment and the direction of turn and are generated at a relay (normally open, N.O., or normally closed, N.C. contact). Connect the outputs as in the figure below:

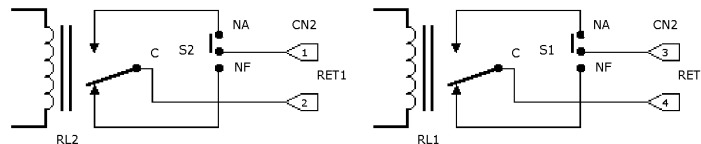

5.8.2.2 Electromagnets

The electromagnets are activated to block the turnstile. Unlike traditional solenoids, electromagnets cause no friction between the spring and the locking device, thus preventing malfunction. Moreover, they are activated by a transistor rather than by a relay, which prevents burning due to stuck contacts (no mechanical wear).

Product Manual

5.8.2.3 Audible alarm

The audible alarm output is activated by an NPN transistor (maximum of 500 mA) whenever the CATRAX Master:

- receives a release signal (two brief beeps);
- has not been released and is forced for one second (one-second beeps);
- stops in the middle of a turn for more than two seconds (one-second beeps).

Connect the audible alarm according to the figure below.

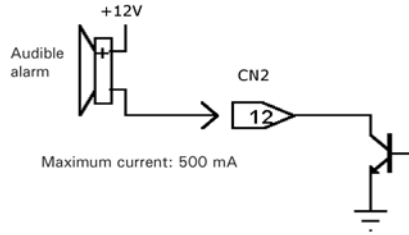

5.8.2.4 Connection diagram

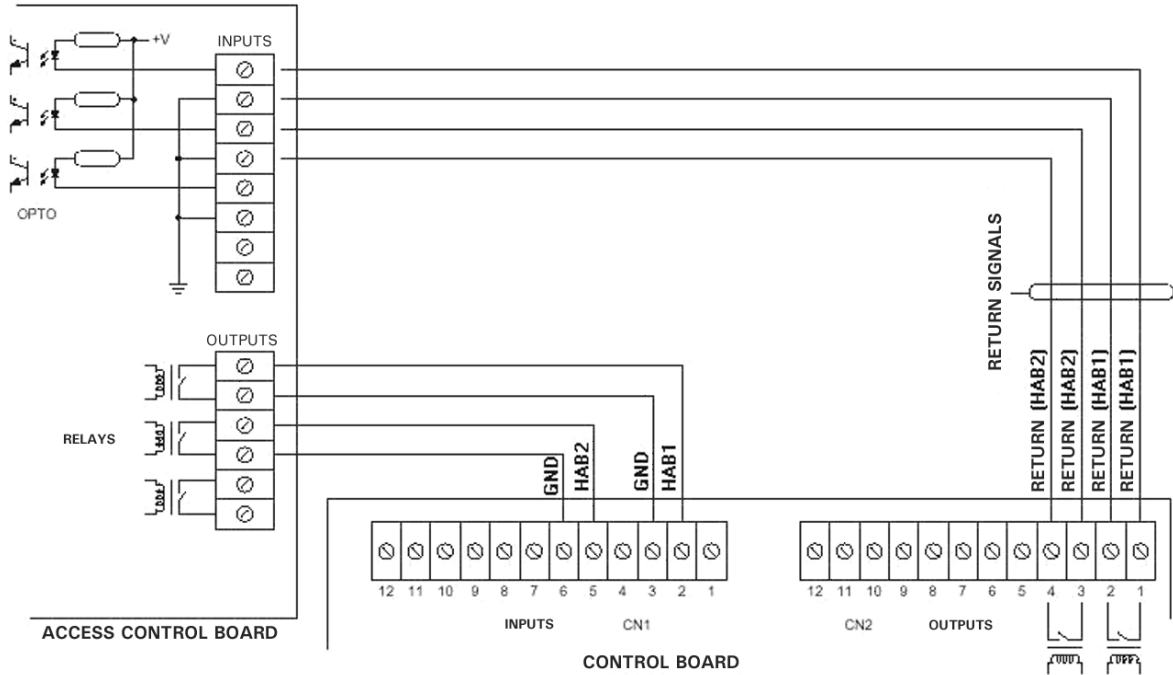

5.8.2.5 Pictogram indicators

Pictogram indicators are activated by NPN transistors (maximum of 500 mA). On activation, a GND signal is sent through the corresponding output.

5.8.2.6 Pictogram connection diagram

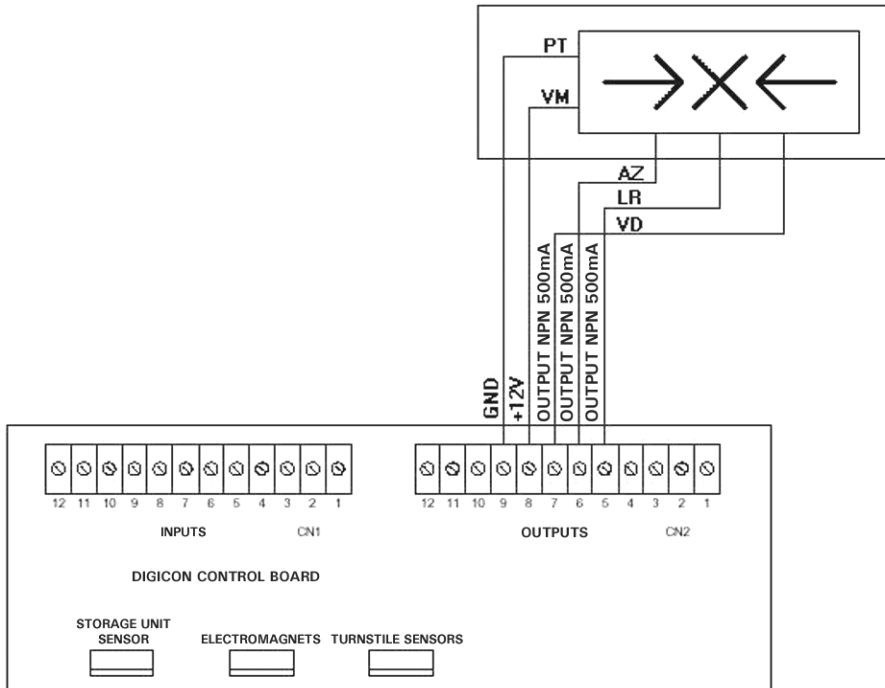

5.8.3 Control board configuration – DS1

Dip-switch DS1 is used to configure the following:

- direction of movement;
- maximum time of passage;
- N.O. inputs (normally open relay or pushbutton pendant switch contacts without input voltage) to enable turn in the presence of these signals, or N.C. inputs (normally closed relay or pushbutton pendant switch contacts with input voltage) to enable turn in the absence of these signals;
- audible alarm signal if the turnstile stops in mid turn for over five seconds.

To program the DS1, place the pins in the positions indicated in the table below.

| | 01 | 02 | 03 | 04 | 05 | 06 | 07 | 08 |
|------------------------------------|-----|-----|-----|-----|-----|-----|-----|-----|
| Free in both directions | - | - | - | OFF | OFF | - | - | - |
| Blocked left to right only | - | - | - | ON | OFF | - | - | - |
| Blocked right to left only | - | - | - | OFF | ON | - | - | - |
| Blocked in both directions | - | - | - | ON | ON | - | - | - |
| N.O. inputs | - | ON | - | - | - | - | - | - |
| N.C. inputs | - | OFF | - | - | - | - | - | - |
| Enable audible signal | ON | - | - | - | - | - | - | - |
| Disable audible signal | OFF | - | - | - | - | - | - | - |
| Enable audible signal in mid turn | - | - | - | - | - | ON | - | - |
| Disable audible signal in mid turn | - | - | - | - | - | OFF | - | - |
| Wait until first turn | - | - | - | - | - | - | ON | ON |
| Wait 5 seconds | - | - | - | - | - | - | OFF | ON |
| Wait 10 seconds | - | - | - | - | - | - | ON | OFF |
| Wait 15 seconds | - | - | - | - | - | - | OFF | OFF |
| Enable by terminal* | - | - | OFF | - | - | - | - | - |
| Enable by level ** | - | - | ON | - | - | - | - | - |

* "Enable by terminal" means that the CATRAX Master will be enabled by a pulse at the entry terminal (N.C. inputs) or exit terminal (N.O. inputs).

** "Enable by level" means that the CATRAX Master will remain free as long as there is an input signal.

Product Manual

5.8.4 Sample configurations

1 – To receive relay pulse (N.O. contact), release turn, and wait 10 seconds for turn:

| | 1 | 2 | 3 | 4 | 5 | 6 | 7 | 8 |
|---------------|---|----|-----|----|----|---|----|-----|
| Configuration | - | ON | OFF | ON | ON | - | ON | OFF |

2 – To always allow turn from left to right and to release turn from right to left for an indefinite period on receiving an HAB2 signal:

| | 1 | 2 | 3 | 4 | 5 | 6 | 7 | 8 |
|---------------|---|----|-----|-----|----|---|----|----|
| Configuration | - | ON | OFF | OFF | ON | - | ON | ON |

3 – To unlock turnstile when the relay contact is closed and to lock arms as soon as the contact is opened:

| | 1 | 2 | 3 | 4 | 5 | 6 | 7 | 8 |
|---------------|---|----|----|----|----|---|----|----|
| Configuration | - | ON | ON | ON | ON | - | ON | ON |

NOTES

- The control board can be fastened to the mounting rack that comes with the CATRAX Master.
- Shaded fields indicate factory configuration.

5.8.5 Serial configuration

The CATRAX Master control board allows serial configuration of the equipment. The communication protocol used is as follows:

| STX | Size(LSB) | Size(MSB) | Commands | BCC |
|-----|-----------|-----------|----------|-----|
|-----|-----------|-----------|----------|-----|

Where:

- **STX** represents beginning of transmission (0x02);
- **Size(LSB)** is the byte with the least significant size component;
- **Size(MSB)** is the byte with the most significant size component;
- **Commands** is the information sent to the equipment (one or two bytes);
- **BCC** is the XOR operation for all bytes sent, from **STX** to **Comandos**.

NOTES

- **Size** corresponds to the number of bytes sent (total command bytes: 1).
- The protocol **communication rate** is 115,200 bps.

The following table shows the enabling commands that can be sent to the CATRAX Master:

| HEX | ASCII | FUNCTION |
|------|-------|---|
| 0x48 | H | Turnstile free right to left |
| 0x41 | A | Turnstile free left to right |
| 0x44 | D | Turnstile free in both directions |
| 0x43 | C | Return to control (command used to exit free state) |
| 0x4C | L | Turnstile free (include direction of free motion: <0x4C> + <0x48>) |
| 0x53 | S | Direction programming (include direction to be programmed: <0x53> + <0x48>) |

The following table shows the return commands sent by the equipment:

| HEX | ASCII | FUNCTION |
|------|-------|---|
| 0x48 | H | Turnstile free right to left |
| 0x06 | ▲ | ACK, indicates OK command |
| 0x15 | § | NACK, indicates invalid command |
| 0x1A | → | Right to left direction return command (RET1) |
| 0x1B | ← | Left to right direction return command (RET2) |

Some sample commands are as follows:

| | | | | | |
|--|------|------|------|------|------|
| Free left to right turn (1 passage): | | | | | |
| 0x02 | 0x02 | 0x00 | 0x48 | 0x48 | |
| Configure left to right turn always free: | | | | | |
| 0x02 | 0x03 | 0x00 | 0x4C | 0x48 | 0x05 |
| Return OK command: | | | | | |
| 0x02 | 0x02 | 0x00 | 0x06 | 0x06 | |

NOTE

For further information on the serial communication configuration, see item 5.7 Control board.

5.9 ANTI-PANIC DROP-ARM SYSTEM

The CATRAX Master turnstile is equipped with an electromechanical anti-panic drop-arm system. This mechanism is composed of a mechanical assembly activated by a high-performance solenoid that keeps the arm raised during normal operation. In the event of a power failure (if the turnstile does not have an uninterruptible power supply installed), in response to a command sent by the system or a push-button located in the control room the solenoid is deactivated and the arm drops, providing barrier-free access. These devices can be connected in series, allowing the arms of all turnstiles connected to a single system to be dropped simultaneously.



The control and monitoring board of the drop-arm system is shown below.

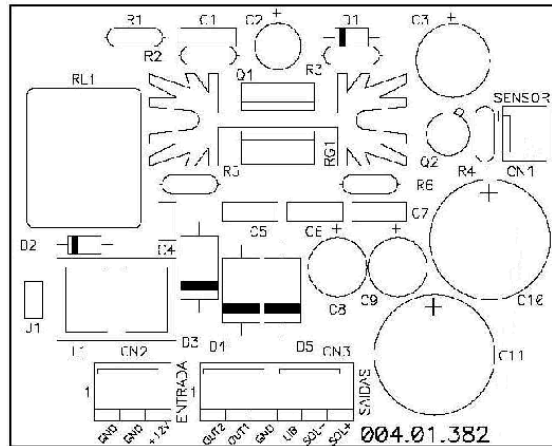

This device requires 12V 2A power supply.

To avoid solenoid overheating, the control board is provided with an automatic routine that reduces the voltage to 6 V 2 seconds after the turnstile is connected to the power supply. Once the arm is dropped, it must be rearmed manually.

5.9.1 Electrical connections

The arm is deactivated by shorting the GND and LIB inputs, as shown in the following diagram.

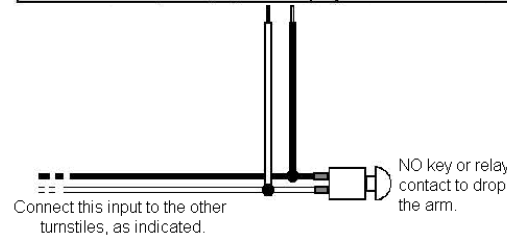
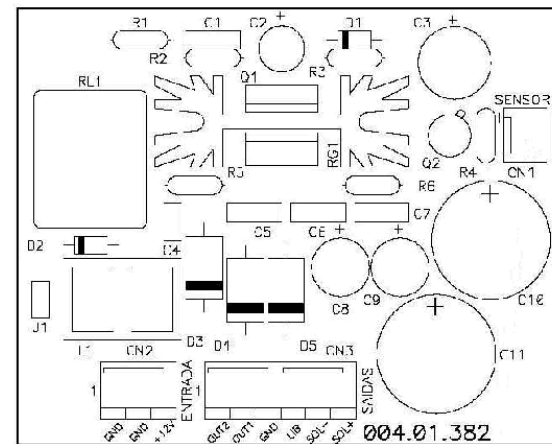

5.9.2 Mounting of arms

The arms are supplied unassembled. In order to mount them, follow the instructions given in the pictures below.

A # 8 Allen wrench should be used, and the screw must be well tightened, in order to guarantee good fixation. All three arms should be fastened at the same superior central point.



1. Let the mini-arm drop.

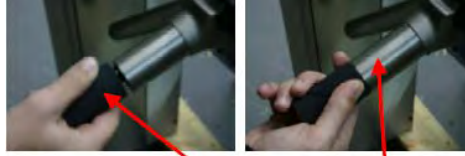

2. Make sure that the plastic part of the mini-arm is fixed to the steel part.



3. Connect the stainless steel arm to the mini-arm.



4. Fasten the screw located inside the mini-arm using a # 8 Allen wrench.



5. Put the arm back to its normal position.

5.9.3 Maintenance tests

The anti-panic drop-arm system was developed to facilitate exit during emergencies. This being so, we recommend that tests and inspections are regularly performed as a preventative measure (at least once a month). We suggest that the card provided with the turnstile be used to record inspections made. For each inspection the date and name and signature of the technician should be completed. If the mechanism shows any sign of a defect, contact TURNSTILES, or an authorised service company, for maintenance.

Each inspection should follow the operational procedure below for each of the three arms:

- place the arm in the horizontal position;
- power off the turnstile;
- check if the arm drops (if the arm does not drop, contact TURNSTILES);
- power on the turnstile;
- raise the arm to its horizontal position (the arm should remain in the horizontal position by itself; in the event that the arm does not remain horizontal without external support, contact TURNSTILES);
- repeat the procedure three times for each arm.

6 MAINTENANCE

6.1 REGULAR MAINTENANCE

Bearing base – Frequency: every 700.000 turns

Check for wear on bearing races.

Corrective action:

1. Replace part in case of excessive wear (shards, perforations, filings or grooves on bearing race).
2. Where no wear is present, clean and grease bearing using bearing grease.

Optical sensors – Frequency: not less than once per year (depending on operating conditions)

This maintenance procedure requires the use of a multimeter. Take measurements at CN6 when the turnstile is powered, according to the instructions below:

- Set multimeter to measure DC voltage up to 20 V. Place black pointer on pin 4 and red pointer on pin 1 of CN6. Voltage should be lower than 0.8 V (non-obstructed sensors). With pointers in the same position, force equipment arms in both directions (in one of the directions, the voltage measured by the multimeter should be higher than 4.5 V).
- Repeat operation with black pointer on pin 4 and red pointer on pin 3. The results should be the same as those obtained with pins 4 and 1.
- Check sensors for signs of dust.

Corrective action:

1. If measurements are not as described, replace defective sensor.
2. Clean sensors with a clean brush.

NOTE

In excessively dusty environments, perform this maintenance procedure more than once a year.

Electromagnets – Frequency: every 700.000 turns

This maintenance procedure requires the use of a multimeter. Disconnect CN3 from the control board and check resistance of electromagnets. The value should be between 12.5 and 13.5 ohms on pins 1, 2, 3, and 4 of the electromagnet connector. Once measurement is complete, CN3 should be reconnected to the board.

Corrective action:

1. Replace electromagnet in case of incorrect resistance, short-circuit or open circuit.
2. If electromagnet is not working, check board and voltage.
3. Tighten bolts on base if electromagnet is loose.

Electromagnet adjustment (if necessary):

1. Force lock against gear and equipment arm until lock is fully within first tooth (until arm is locked).
2. Release fastening bolts and press electromagnet against lock buffer so that its full area is in contact with electromagnet.
3. Tighten bolts again.

Product Manual

Lock assembly – Frequency: every 700.000 turns

In order to check the need for corrective action:

- Check correct lock position.
- Check for wear and fit between lock and gear.

Corrective actions:

1. If lock is incorrectly positioned, check retention ring and tension spring.
2. If lock is not fitted to gear, replace lock or gear.
3. In case of wear to end of lock, replace lock.

Gear assembly – Frequency: every 700.000 turns

In order to check the need for corrective action:

- Check gear tooth wear.
- Check backlash between central shaft, gear and cotter pin.

Corrective actions:

1. In case of wear to teeth, replace gear.
2. In case of excessive backlash between gear and shaft/cotter pin assembly, replace gear or cotter pin. To change cotter pin, use a pulley puller.

6.2 TROUBLESHOOTING

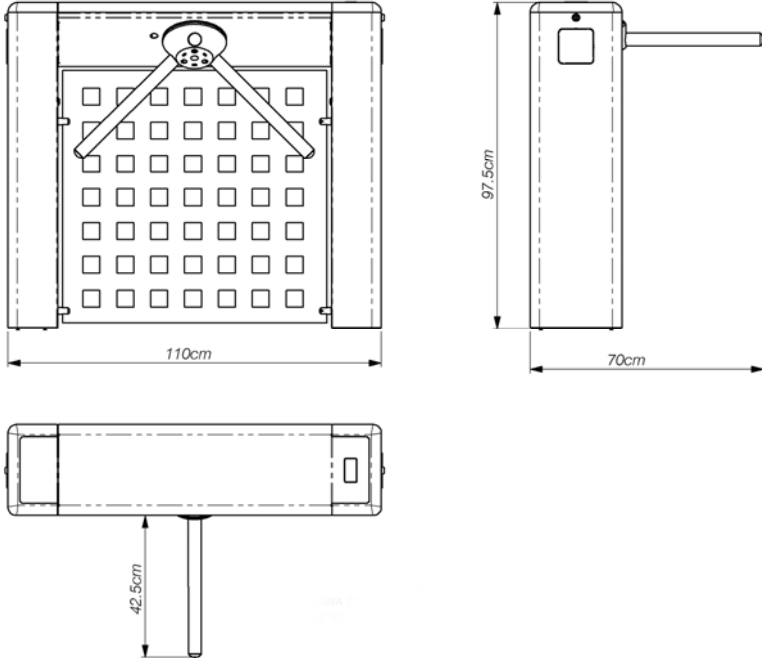
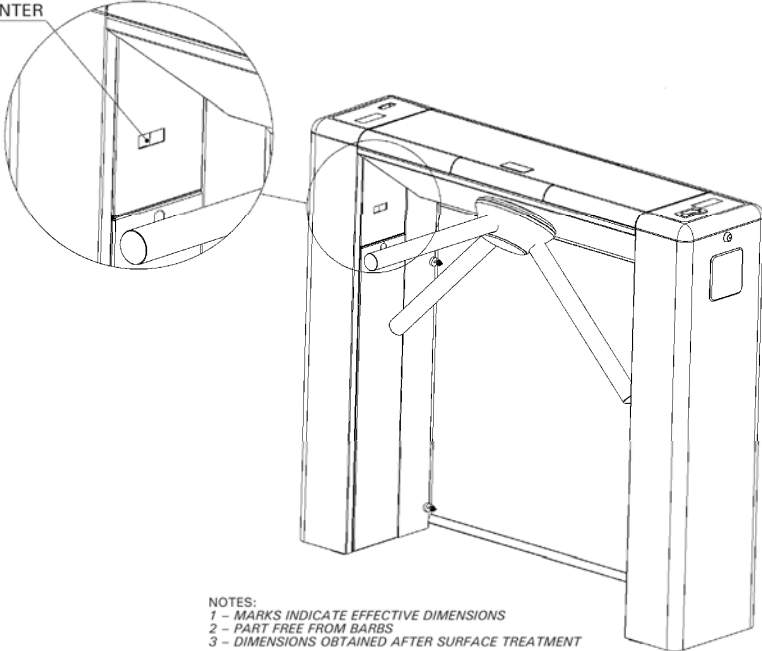

| Problem | Possible cause | Remedy |
|--|--|--|
| <ul style="list-style-type: none"> • CATRAX Master will not turn on | <ul style="list-style-type: none"> • Power supply cable is not connected properly • Power supply fuse is burnt | <ul style="list-style-type: none"> • Check wires and fuse (fuse: 3 A) |
| <ul style="list-style-type: none"> • CATRAX Master is locked | <ul style="list-style-type: none"> • Optical sensors are obstructed or defective | <ul style="list-style-type: none"> • Carry out maintenance procedures for sensors or send equipment to Technical Assistance |
| <ul style="list-style-type: none"> • CATRAX Master will not activate electromagnet (turnstile cannot be locked) | <ul style="list-style-type: none"> • Cable is broken or distance between electromagnet and lock device is maladjusted | <ul style="list-style-type: none"> • Adjust electromagnet or send equipment to Technical Assistance |
| <ul style="list-style-type: none"> • Arm will not stay in correct position | <ul style="list-style-type: none"> • Bearing base is worn, dirty, not properly lubricated, or spring is broken | <ul style="list-style-type: none"> • Request replacement of defective part or send equipment to Technical Assistance |
| <ul style="list-style-type: none"> • CATRAX Master will not lock on first tooth | <ul style="list-style-type: none"> • Distance between electromagnet and lock device is maladjusted | <ul style="list-style-type: none"> • Adjust electromagnet or send equipment to Technical Assistance |

7 TECHNICAL CHARACTERISTICS

| Dimensions | |
|------------------|---|
| Fully assembled: |  <p>110cm</p> <p>97.5cm</p> <p>70cm</p> <p>42.5cm</p> |
| Blockage counter | <p>DIGITAL COUNTER</p>  <p>NOTES: 1 - MARKS INDICATE EFFECTIVE DIMENSIONS 2 - PART FREE FROM BARBS 3 - DIMENSIONS OBTAINED AFTER SURFACE TREATMENT</p> |

| | |
|---|---|
| <p>Central cover</p> | |
| <p>Central brushed stainless steel finish</p> | <p>NOTE: $\triangle A$ INDICATES BRUSHED SURFACE</p> |
| <p>Outer covers</p> | |

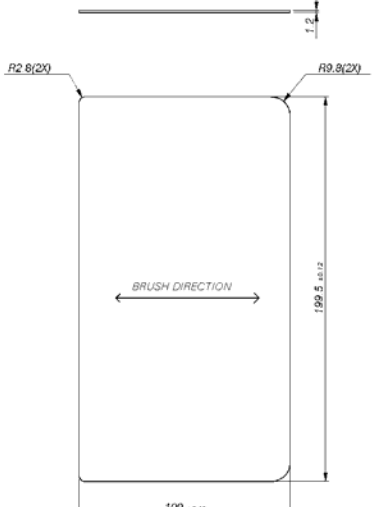
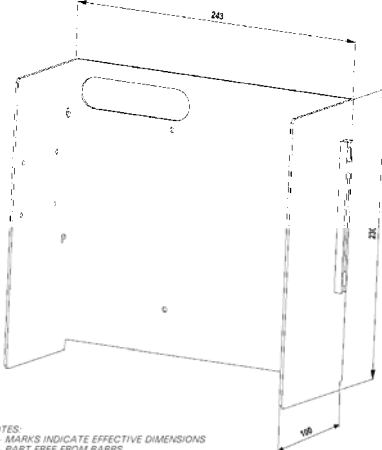
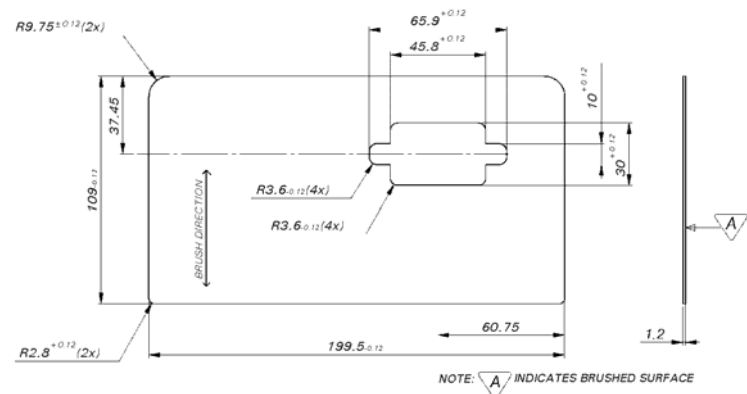
Product Manual

| | |
|--|--|
| <p>Stainless steel finish</p> |  |
| <p>Internal drawer mount</p> |  <p>NOTES: 1 - MARKS INDICATE EFFECTIVE DIMENSIONS 2 - PART FREE FROM BARBS 3 - DIMENSIONS OBTAINED AFTER SURFACE TREATMENT</p> |
| <p>Stainless steel finish for slot</p> |  <p>NOTE:  INDICATES BRUSHED SURFACE</p> |
| <p>Packaging:</p> | <p>116 cm x 42 cm x 112 cm</p> |
| <p>Other information</p> | |
| <p>Gross weight:</p> | <p>approximately 60 kg (including packaging)</p> |
| <p>Distance between arms</p> | <p>120 degrees</p> |
| <p>Electromagnet power supply voltage:</p> | <p>12 V and 2 A</p> |
| <p>Sensor power supply voltage:</p> | <p>5 V and 0.05 A</p> |

| | |
|------------------------------|---|
| Power supply unit (optional) | Input: 85 V to 250 VAC Output: 12.3 V \pm 5% / 2 A and 5 V \pm 5% / 1 A Dimensions: 35 x 51 x 105 mm Distance between holes: 43 x 98 mm Hole diameter: 3.5 mm |
| Board with display | Power supply: 6 to 24 VDC / 100 mA |

8 WARRANTY AND TECHNICAL ASSISTANCE

TURNSTILES is responsible for the design and the good quality of the labor and materials used in the manufacturing of its products, guaranteeing the equipment and all its parts to be free from defects and faulty material or manufacturing. TURNSTILES promises to replace or repair any part or equipment that it finds to show any manufacturing fault at no expense to the buyer, under the following conditions:

1. Transportation expenses to and from TURNSTILES will be the buyer's responsibility.
2. The warranty starts on the date of purchase, as recorded in the invoice. The warranty covers:
 - a) Five (5) years for replacement of equipment, accessories and parts;
 - b) Ninety (90) days for repairs and technical assistance.
3. Warranty is not valid without invoice (original or copy).
4. The warranty is not valid in the following cases and conditions:
 - a) defects and damage caused by accidents, negligence, or acts of god;
 - b) defects and damage caused by inadequate or prolonged storage;
 - c) defects and damage that may be attributed to inadequate use of the equipment;
 - d) defects and damage caused by improper installation and operation.
5. The warranty will be automatically void if:
 - a) the equipment is modified, adapted or altered by the customer or a third party without TURNSTILES' express consent;
 - b) the equipment undergoes maintenance or repairs executed by personnel not authorized by TURNSTILES;
 - c) the equipment has its serial number changed or identification tag violated;
 - d) payment is not made according to the conditions stated in the invoice.
6. TURNSTILES will not be responsible for any damage that may occur as a result of the equipment being inactivated.
7. Repair of the equipment under warranty will be made at TURNSTILES.