

* DIMENSIONS MAY VARY IN ACTUAL INSTALLATION - FABRICATION CHANGES RESERVED - SIMILAR EQUIPMENT MAY BE SUBSTITUTED *

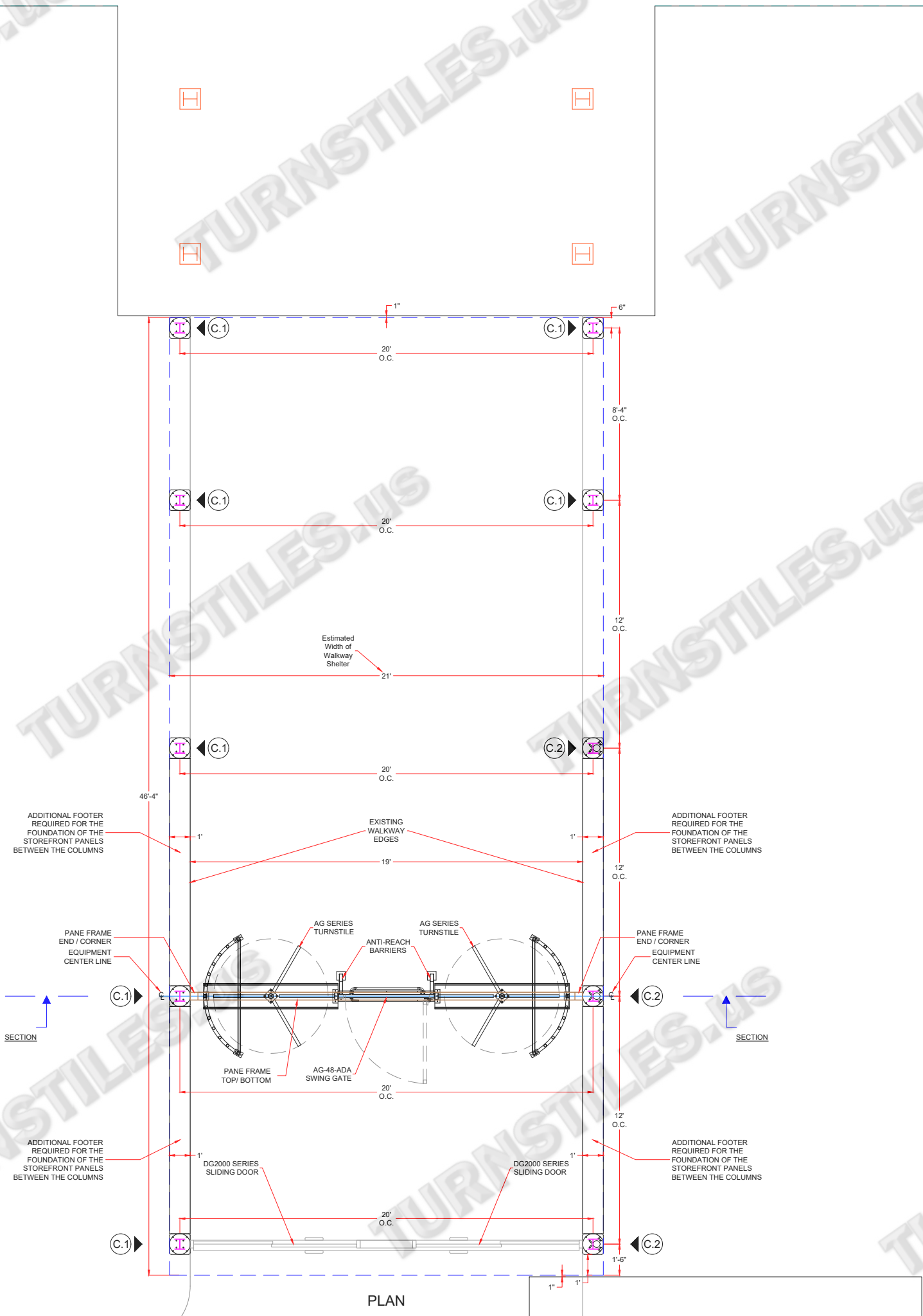

C x10
REFERENCE
COLUMN, CAISSON, AND ANCHOR DETAIL

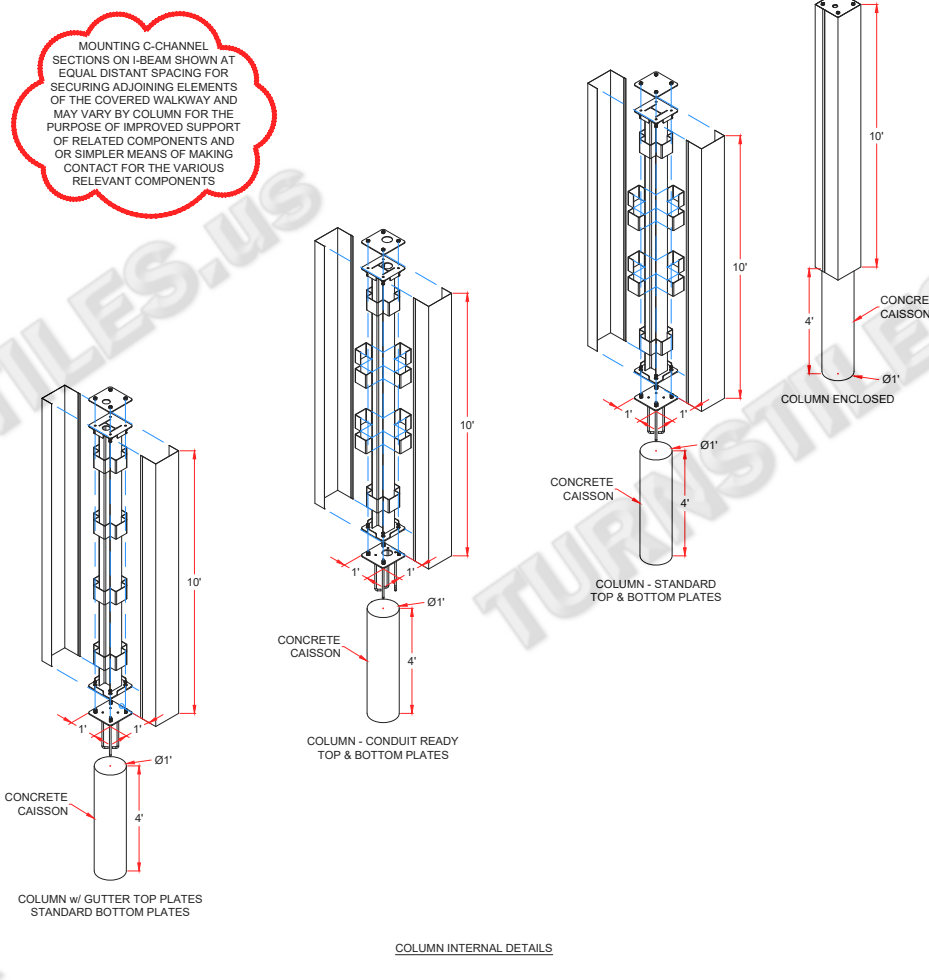
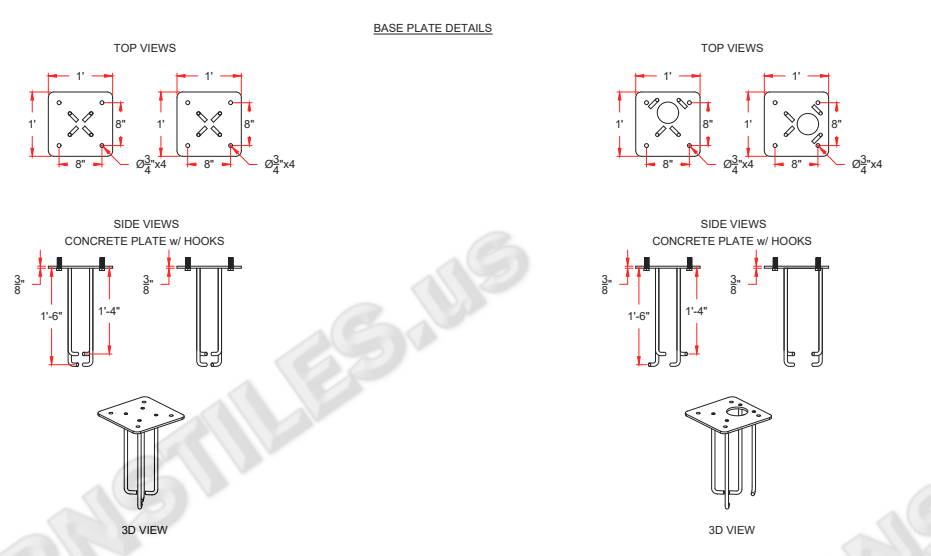
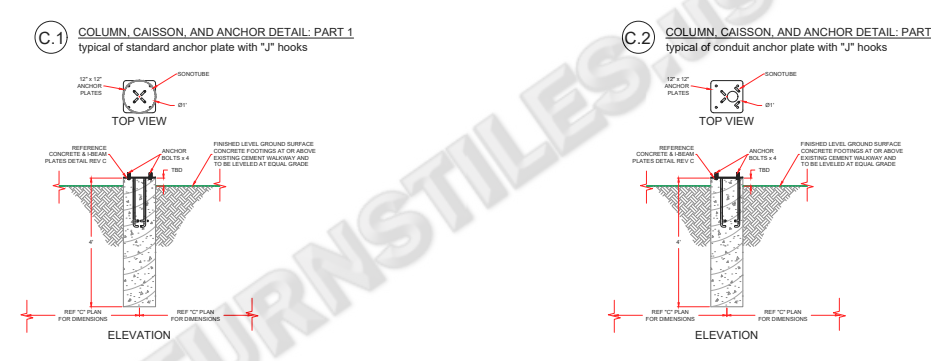
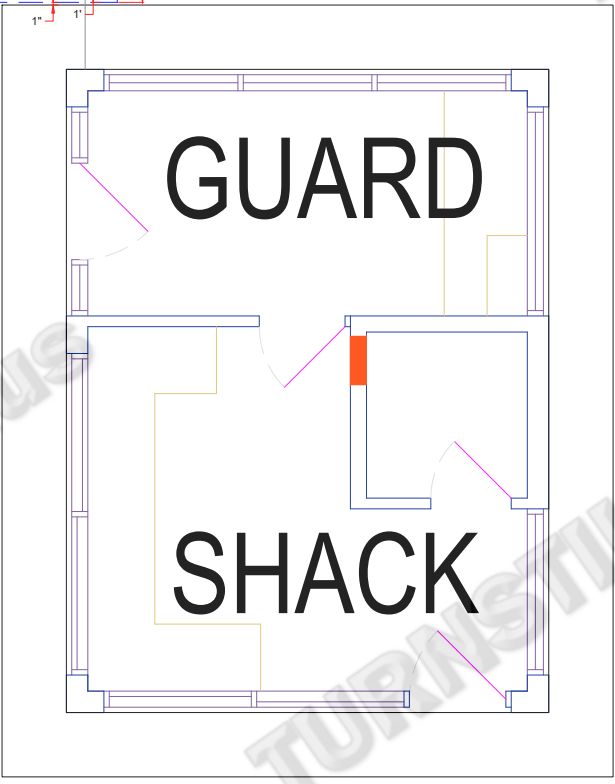

FIRST DRAWN	BY
10-19-20	CJC
REVISED	BY

COPYRIGHT © TURNSTILES.US
 Copyright © Turnstiles.us All rights reserved. Reproduction or translation of this work without the express written permission of TURNSTILES.US is unlawful and is an infringement of intellectual property belonging to TURNSTILES.US.
 All drawings and/or designs are restricted for use exclusively with a purchase, installation, and/or support from Turnstiles.us. Any other use of these materials is a violation of copyright law. Request for additional information should be addressed to the Legal Department, Turnstiles.us.

TURNSTILES.US

www.TURNSTILES.us
 Call 303 670 1099 * Text 303 918 9787
 patrick.mcallister@turnstiles.us

Equipment Location Detail	
KraftHeinz	
THE KRAFT HEINZ COMPANY	
DWG	10-19-20 KRAFT-HEINZ COVERED WALKWAY ELD REV C
DATE	10-19-20
SHEET - 1 OF 3	

AUTHORIZED SIGNATURE: _____ DATE: ___ / ___ / ___

* DIMENSIONS MAY VARY IN ACTUAL INSTALLATION - FABRICATION CHANGES RESERVED - SIMILAR EQUIPMENT MAY BE SUBSTITUTED *

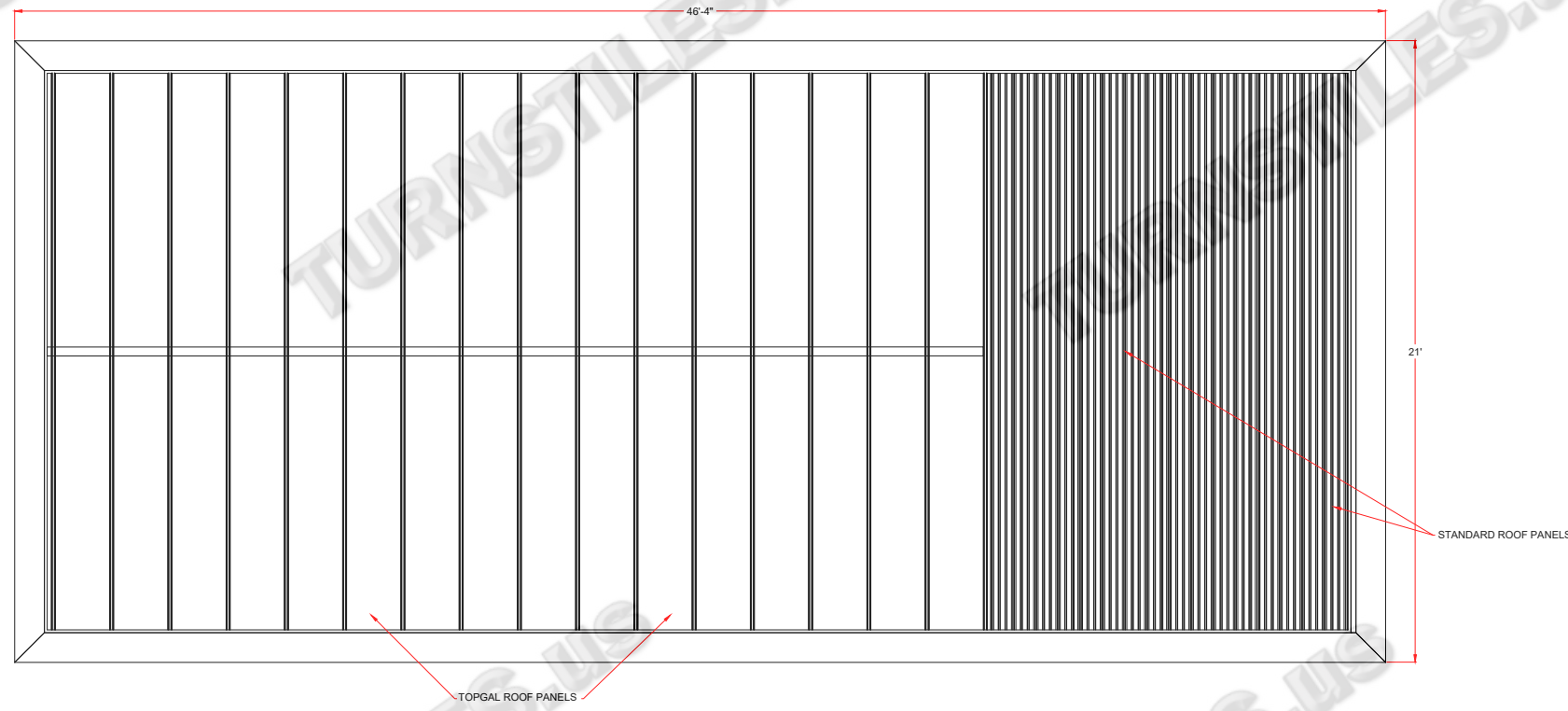

ROOF - OVERHEAD DETAIL

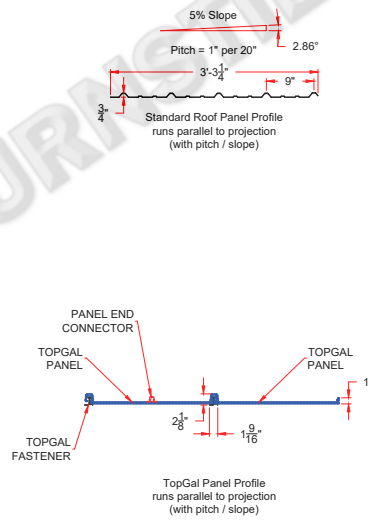

ROOFING TYPE(S) - PROFILES - DETAILS

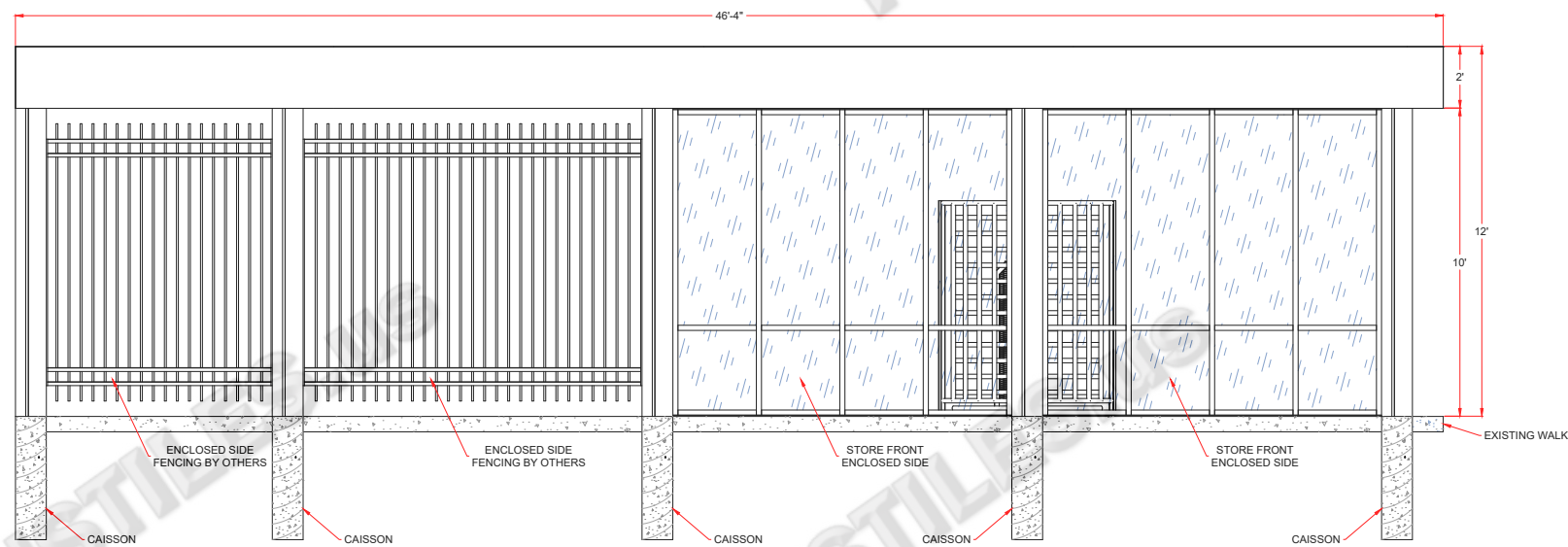

ELEVATION - LEFT SIDE

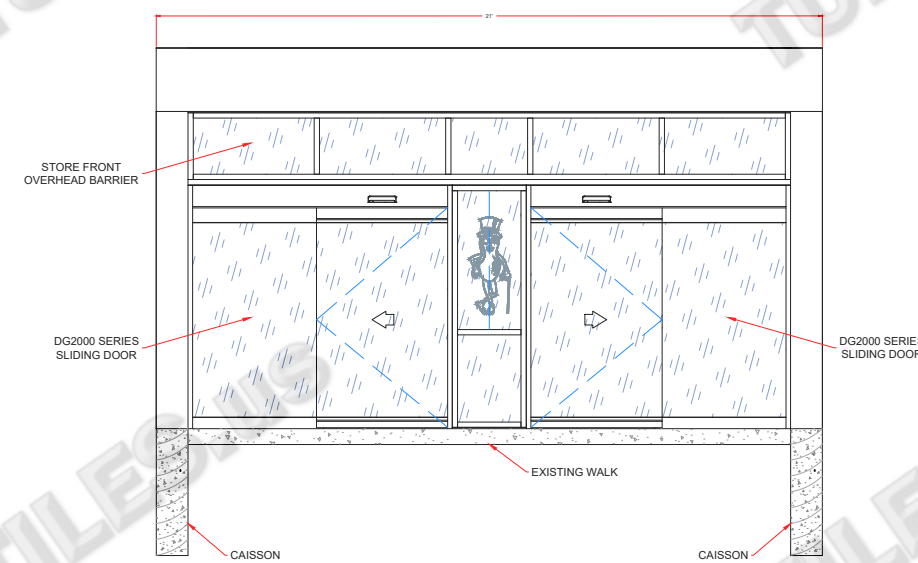

ELEVATION - SLIDING DOORS

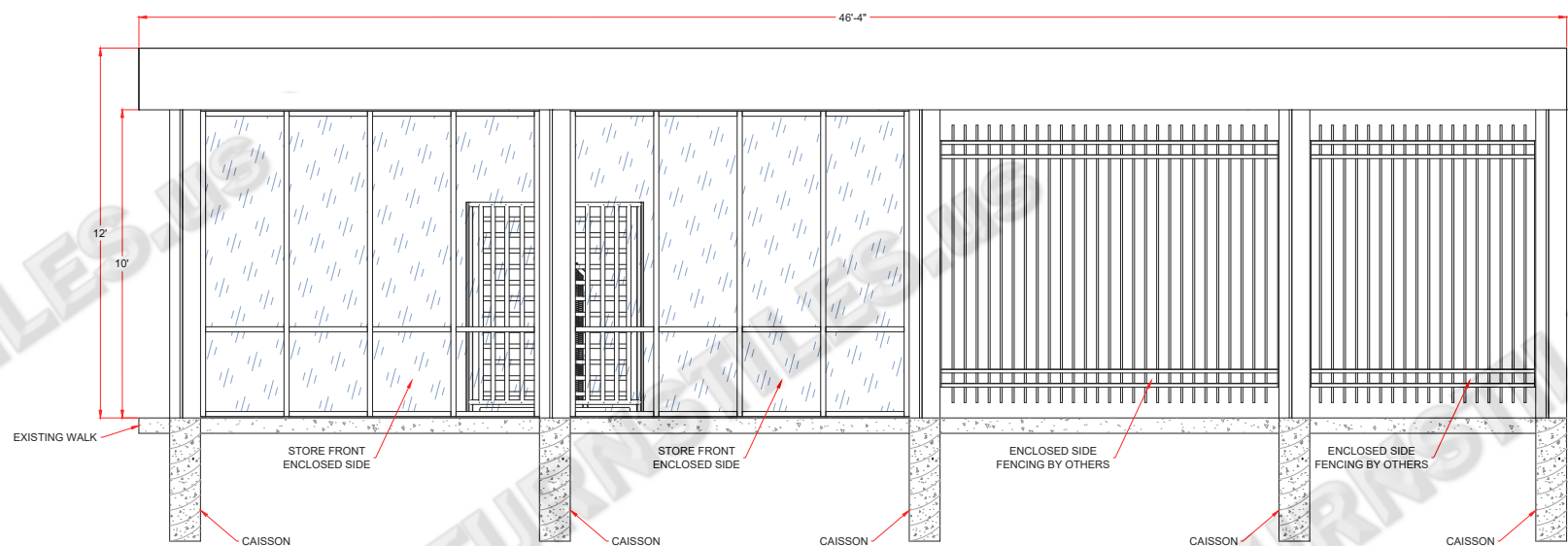

ELEVATION - RIGHT SIDE

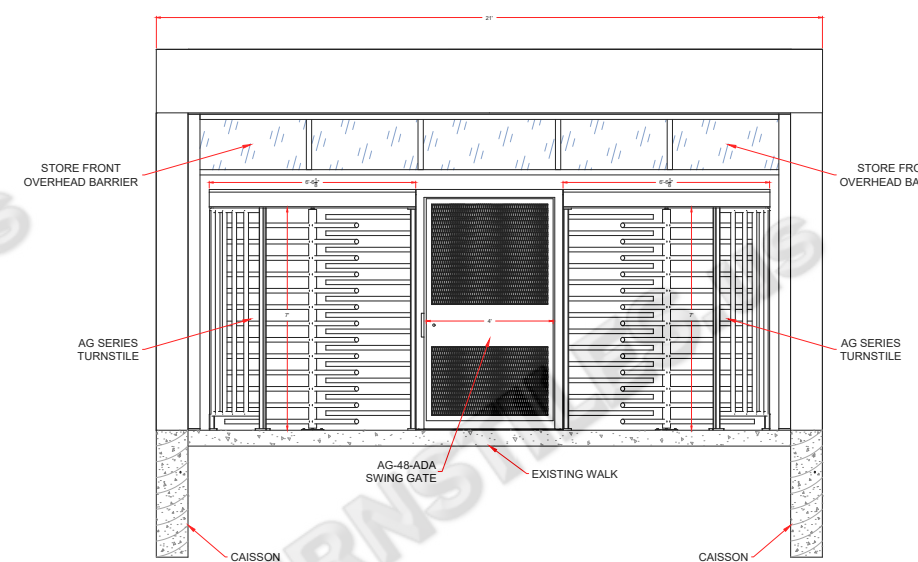

ELEVATION - TURNSTILES & SWING GATE

AUTHORIZED SIGNATURE: _____ DATE: ___ / ___ / ___

FIRST DRAWN	BY
10-19-20	CJC
REVISED	BY

COPYRIGHT © TURNSTILES.US
 Copyright © Turnstiles.us All rights reserved. Reproduction or translation of this work without the express written permission of TURNSTILES.US is unlawful and is an infringement of intellectual property belonging to TURNSTILES.US.
 All drawings and/or designs are restricted for use exclusively with a purchase, installation, and/or support from Turnstiles.us. Any other use of these materials is a violation of copyright law. Request for additional information should be addressed to the Legal Department, Turnstiles.us.

TURNSTILES.US

www.TURNSTILES.us

Call 303 670 1099 * Text 303 918 9787

patrick.mcallister@turnstiles.us

Equipment Location Detail

KraftHeinz
 THE KRAFT HEINZ COMPANY

DWG 10-19-20
 KRAFT-HEINZ
 COVERED WALKWAY
 ELD REV C

DATE 10-19-20

SHEET - 2 OF 3

* DIMENSIONS MAY VARY IN ACTUAL INSTALLATION - FABRICATION CHANGES RESERVED - SIMILAR EQUIPMENT MAY BE SUBSTITUTED *

FIRST DRAWN	BY
10-19-20	CJC
REVISED	BY

COPYRIGHT © TURNSTILES.US
 Copyright © Turnstiles.us All rights reserved. Reproduction or translation of this work without the express written permission of TURNSTILES.us is unlawful and is an infringement of intellectual property belonging to TURNSTILES.us.
 All drawings and/or designs are restricted for use exclusively with a purchase, installation, and/or support from Turnstiles.us. Any other use of these materials is a violation of copyright law. Request for additional information should be addressed to the Legal Department, Turnstiles.us.

TURNSTILES.US
 www.TURNSTILES.us
 Call 303 670 1099 * Text 303 918 9787
 patrick.mcallister@turnstiles.us

Equipment Location Detail

KraftHeinz
 THE KRAFT HEINZ COMPANY

DWG	10-19-20 KRAFT-HEINZ COVERED WALKWAY ELD REV C
DATE	10-19-20
SHEET - 3 OF 3	

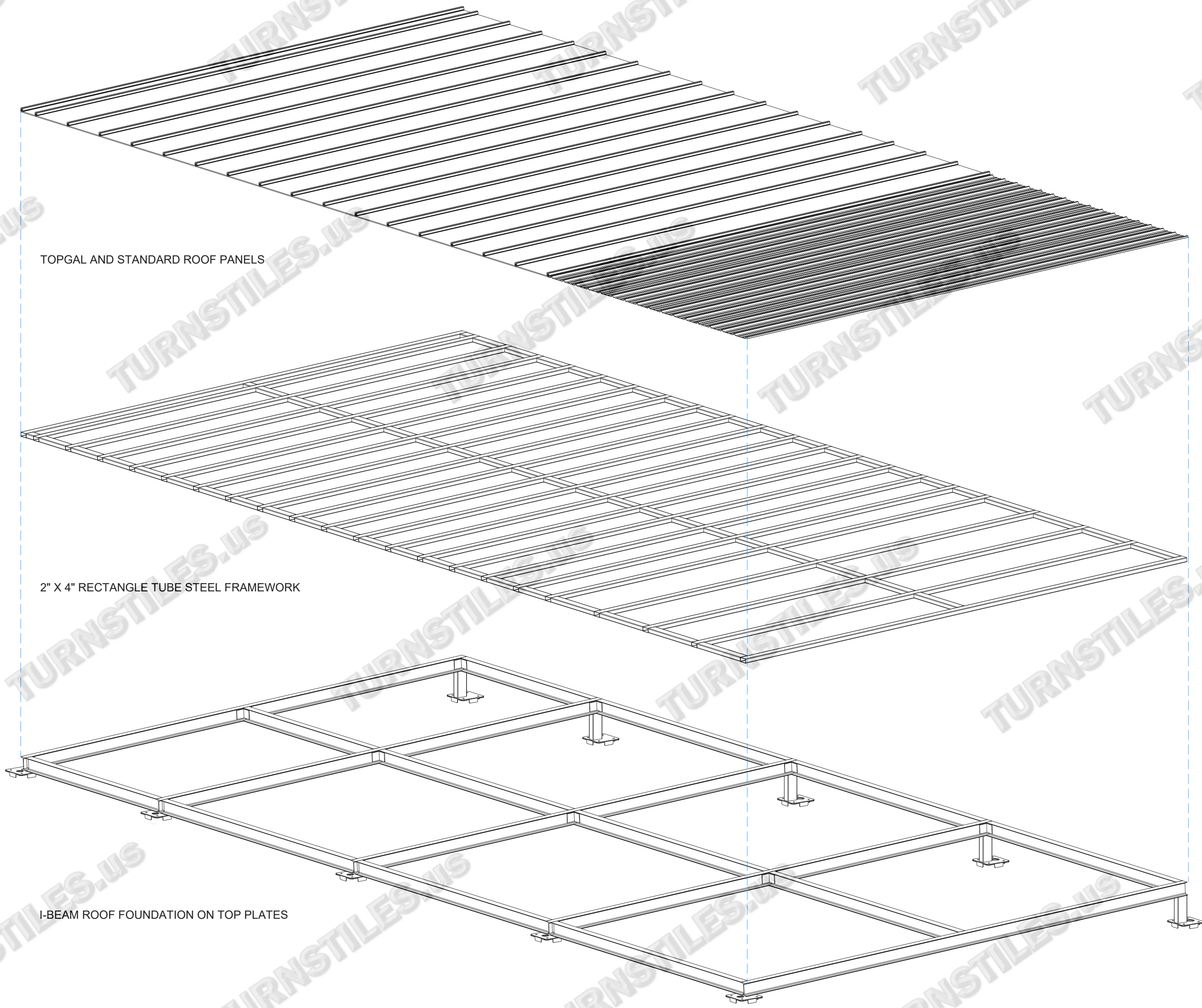

ROOF - OVERHEAD EXPLODED DETAIL

AUTHORIZED SIGNATURE: _____ DATE: ___ / ___ / ___