

Single Door Entry Control



Alarm: Indoor/outdoor armored siren with optional strobe light. The full featured siren consists of a single tone that delivers a warble sound output. It features light weight, rust-proof aluminum die-cast housing, a 122 dB output siren driver, and a dual action normally open reed plunger switch for normally closed loop.



Exit Bar: This device features a unique interlocking grip action to secure the door to the jamb without conventional roller strikes or retracting latches. In addition, an interlocking mechanism located in the chassis offers a double interlocking system which makes these exit devices virtually impossible to tamper with, pry or force open.

Secure Any Door in your Facility

This solid system* is quick to install, and communicates with EntraPass Special, Corporate and Global Edition security software, version 6.02 or higher.

The Parts



Door Controller: The KT-1 controller is a two-reader, single lock Ethernet-based door controller. Door monitoring for hold-open alarming. It manages 100,000 cards in stand-alone mode, and 18,000 events.



Door lock: Electromagnetic lock with 1200 lbs. holding force and automatic dual voltage.

Card reader: ioProx Proximity Reader. Compatible with dual encoded proximity cards - 26-bit Wiegand and Kantech XSF. Digital Signal Processing (DSP) ensures quick and reliable card reading.

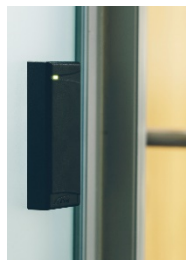

Weatherproof design for indoor and outdoor applications. Integrated piezoelectric buzzer & bicolor reader LED. Quick connect terminal blocks (P225 and P325 series) allows for easy wiring and saves time and money. Up to 29 inch read range (P600).

How it Works

*Integration options and upgrades are available upon request.

KT-1

Ethernet-Ready, One Door Controller

Features That Make a Difference:

- Supports 2 readers (entry and exit)
- Single touch-sensitive button for fast controller enrollment
- Plug & play installation
- Interchangeable connections for easy install or replacement
- Flexible power input – Power over Ethernet (PoE), PoE+ or 12 VDC
- Compact and attractive design – install it anywhere
- Built-in electronic tamper
- Choose from single gang mount (model KT-1) or cabinet mount (KT-1-PCB) installation options
- Compatible with existing Kantech controllers including KT-300 and KT-400
- Compatible with EntraPass Security Management Software v6.02 or higher



KT-1



KT-1-PCB

One Touch

The KT-1 controller features a touch-sensitive button for plug and play installation. Simply provide an IP connection, push a single button and you're done. There is no need to manually enter MAC/Serial numbers. With its innovative single button programming, the KT-1 is automatically detected and enrolled onto the EntraPass security management software (v6.02 and higher).

With its Ethernet port for direct network connection, its Power over Ethernet capabilities and its unique single button programming, the KT-1 controller is up and running in just a few simple steps.

Head IP Controller Function

A single KT-1 can act as a 'head IP controller', linking together 31 additional controllers under one IP connection in EntraPass. This significantly reduces the amount of IP connections required to EntraPass and reduces programming time on the software. Thus creating installation cost benefits and a highly scalable solution.

Alarm Panel Integration

DSC PowerSeries (including NEO) or MAXSYS alarm panel data integration can be accomplished by connecting it to the KT-1 controller (KT-1-PCB model only). Using this controller; EntraPass Special, Corporate or Global Editions are able to receive intrusion events, view

the status of zones and partitions, and program users' code. In addition the system can be armed/disarmed (single or multiple partitions) via the reader or manual operation from the workstation.

Secure and Efficient Network Communication

The KT-1 is compatible with EntraPass software and uses 128-bit AES encryption to ensure secure communication. It also acts as a polling device to ensure the controllers communicate with EntraPass only as required, reducing network traffic. Flexible options allow KT-1 to connect to EntraPass via:

- On-board IP (Ethernet) port
- RS-485 (COM1) port for communication between the EntraPass Gateway/Kantech Network Communication Controller (KT-NCC) and KT-300/KT-400 door controllers



Combine the new KT-1 controller with EntraPass security management software and the EntraPass Web and Go mobile applications to create an innovative solution that installs quickly, can be managed remotely and provides a superior user experience.

Physical

KT-1

Plastic Housing Dimensions
(H x W x D) 12.9 x 8.6 x 4.6 cm (5.1 x 3.4 x 1.8 in)
Weight 305 g (10.8 oz)

KT-1-PCB

Dimensions (H x W x D) 13.8 x 12.1 x 4.8 cm (5.4 x 4.8 x 1.9 in)
Weight 395 g (13.9 oz)

Environmental

Operating Temperature 2° to 40°C (35° to 104°F)
Operating Humidity 0% to 95% non-condensing

Electrical

KT-1/KT-1-PCB Power Input . . . 12 VDC / PoE / PoE+, 2.2 A
Reader Power Output Maximum 0.5 A @ 12 VDC, typical 250mA per reader, protected and supervised
Lock Device Power 12VDC, typical 750mA supervised (PoE+ & 12vdc power input) & 12VDC, typical 250mA supervised (PoE)

Operational

One Button Enrollment Capacitive touch-sensitive button
Reader Types Wiegand, proximity, ABA clock and data, bar code, magnetic, integrated keypad, smart card, RS-485 (Kantech Protocol)

Number of Cards in Stand-Alone Mode 100,000 (KT-1 and KT-1-PCB)
Monitored Points (Inputs) 4 monitored points, single EOL, double EOL (Independently programmable)
Reader Outputs LED and buzzer (25 mA maximum each, open collector outputs)
Auxiliary Outputs OUT3 and OUT4 (25 mA each, open collector outputs)
KT-1 Controlled Output Relay . . . 2 controlled output relays, 12 VDC, 25 mA each, open collector (optional relay KT-RM1 also available)

KT-1-PCB Controlled Output Relay (R1, R2) 2 onboard form C controlled outputs relays, 30 VDC, 3 A max each
Communication Ports RS-485, Ethernet 10/100Base-T with RJ-45
Expansion Port RS-485
Auxiliary Port Auxiliary 12 VDC, 500 mA maximum
Communication Speed Up to 115,200 baud (automatic detection over RS-485); 10/100Base-T over Ethernet
Flash Memory 256 MB for application and data storage (configuration and events can reside for a minimum of 10 years without power)
RAM 128 MB for application loading and running
Network Autonomy Distributed data and processing

Model Numbers

KT-1 Ethernet-ready, one door controller, single gang mount
KT-1-M Ethernet-ready one door controller (KT-1-PCB) and metal cabinet (KT-1-CAB-M)
KT-1-PCB Ethernet-ready, one door controller, cabinet mount

Accessories

KT-1-CVR Black plastic replacement cover, fits KT-1 and KT-1-PCB
KT-1-CAB-M Black metal cabinet, fits KT-1-PCB (H x W x D) 29.9 x 28.8 x 7.7 cm (11 3/4 x 11 3/8 x 3 in)

Regulatory

EN60839-11-1 Grade 1, EN50130-4:2011, EN55022, EN60950, FCC
UL, UL-294, UL-1076
IC, NMB-003, C-Tick
CE

System Diagram

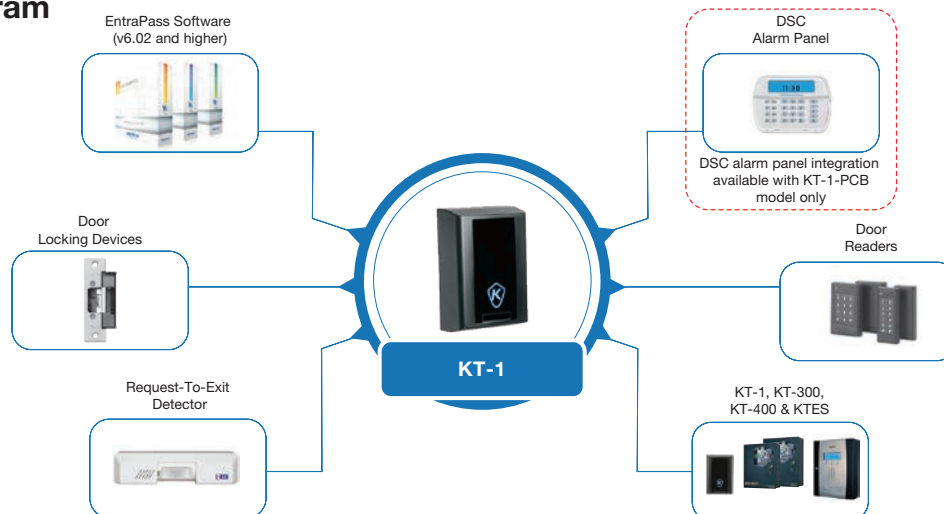

Related Products



DSC Alarm Panels



ioProx Readers



Illustra IP Cameras



EntraPass Security Software

Approvals



M68 Series 1200lb Holding Force Magnalock®

Application - 1200 lb. holding force Magnalock with automatic dual voltage. This model offers a built-in wire access chamber and new bracket mount design for a unique method of installation. Recommended for interior and perimeter doors through which criminals could gain entrance to cause substantial economic loss.

Features and Benefits

- Patented instant release circuit - no residual magnetism
- Surface mounts easily with mounting bracket using a minimum of tools
- Internal wire access chamber
- Mounted using steel machine screws into blind finishing nuts
- Brushed aluminum finish
- All ferrous metal surfaces plated to MIL specification
- Automatic dual voltage - no field adjustment required
- Dress covers available
- Lock options include door position switch, LED indicator and anti-tamper switch
- UL Listed

Specification Data

Holding Force: 1200 lbs. [544 Kg.]

Current Draw and Voltage: 250mA at 12VDC
125mA at 24VDC

Operating Temperature: +32 to +110F [0 to +43C]

Shipping Weight: 13 lbs.

Warranty: MagnaCare Lifetime Replacement Warranty

How To Order

Part #	Description
M68	Magnalock Model M68
M68D	M68, Door Position
M68DL	M68, Door Position, LED
M68DLS	M68, Door Position, LED, Senstat
M68DLST	M68, Door Position, LED, Senstat, Tamper
M68DLT	M68, Door Position, LED, Tamper
M68DS	M68, Door Position, Senstat
M68DST	M68, Door Position, Senstat, Tamper
M68DT	M68, Door Position, Tamper
M68L	M68, LED
M68LS	M68, LED, Senstat
M68LT	M68, LED, Tamper
M68S	M68, Senstat
M68ST	M68, Senstat, Tamper
M68T	M68, Tamper

NOTE: An offset strike may be required for proper installation of the M68 in aluminum frame door applications. See M68 offset strikes on next page

Optional M68 Brackets & Accessories

Prefix	Description
SFP	Stop Filler Plate
UHB	Universal Header Bracket
DC	Dress Cover
TJ	Top Jamb Kit (inswing)

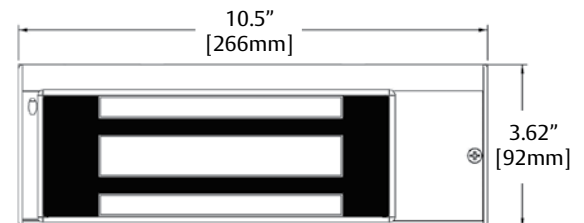
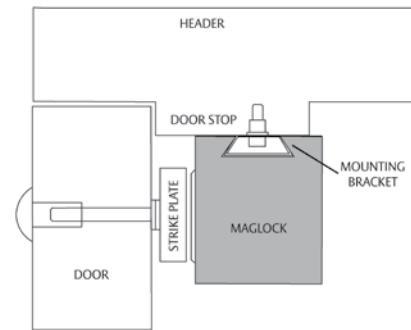
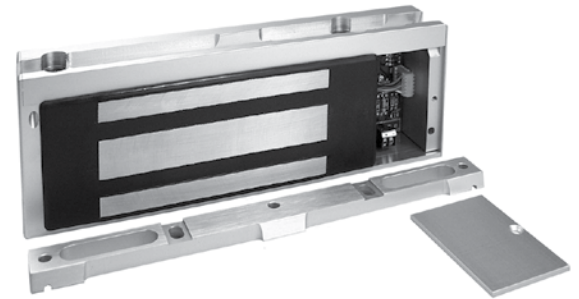
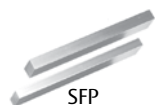

The M68 requires 2.25 inches of flat mounting space

PHYSICAL ACCESS SOLUTIONS

ioProx Proximity Readers and Cards



Features That Make a Difference:

- Readers are compatible with dual-encoded proximity cards - 26-bit Wiegand and Kantech XSF
- Kantech XSF cards can be encoded with over four billion unique codes
- Digital Signal Processing (DSP) ensures quick and reliable card reading
- Weatherproof design for indoor and outdoor applications
- Integrated piezoelectric buzzer & bicolor reader LED
- Quick connect terminal blocks (P225 and P325 series) allows for easy wiring and saves time and money
- Up to 73 cm (29 in) read range (P600)

Integration by Design

Kantech ioProx readers and cards provide an ideal access control solution. They are a secure and easy-to-install solution to manage and control access all the while ensuring people, materials and operations are safe. ioProx readers and cards seamlessly integrate with Kantech access control systems including door controllers and EntraPass Security Software.

Encoding & Authentication

All ioProx readers are compatible with dual encoded proximity cards - 26-bit Wiegand and Kantech Extended Secure Format (XSF). The XSF cards can be encoded with over four billion codes, ensuring no duplication. ioProx keypad readers provide a powerful security solution. Combine an ioProx card presentation with a personal identification number (PIN) to support dual authentication of identity.

Presenting Our Credentials

ioProx cards feature proven, reliable technology that seamlessly integrates with ioProx readers. Cards are available in a variety of shapes and materials. They offer a flexible design and can be attached to a key ring, badge clip or lanyard. In the case of disk shaped P50TAG, it can be attached to any non-metallic surface such as a smart phone. And some cards are suitable for dye sublimation printing.

Selecting The Right Reader

ioProx readers can be selected based on mounting options (single gang box or mullion), compatible card formats (26-bit Wiegand or Kantech XSF), read range and authentication (card or card plus PIN).

Read Range

Depending on the model selected and the operating conditions, read range varies from 16.5 cm to 73 cm (6.5 in to 29 in). With its extended range, the P600 Long Range Reader is ideal for parking lots and other long read range applications.

Appealing/Durable Readers

ioProx readers are attractive, compact, weatherized and vandal-resistant, making them suitable for installation in a variety of indoor and outdoor environments. The bicolor reader LED indicates system status. The LED turns green to indicate a successful read when the card is presented to the reader. In addition, the LED can indicate if the alarm system is armed or disarmed. The piezoelectric buzzer provides audible indication of a successful read.

ioProx Card Reader Selection Chart

Common ioProx Card Reader Specifications

Compatible Card Formats. Dual encoded - XSF (Kantech Extended Secure Format) and 26-bit Wiegand
 LED Indicator. Bicolor (Red, Green)
 Piezoelectric Buzzer Integrated
 Operating Temperature Range. -35°C to 65°C (-30°F to 150°F)
 Color Black

Model Number/Description	Dimensions (h x w x d)	Read Range	Power Supply	Maximum Cable Distance
P225XSF, P225W26 Mullion Mount	11.4 x 4.4 x 2.1 cm (4.5 x 1.75 x 0.84 in)	Up to 16.5 cm (6.5 in)	4.5 to 14 VDC, max. 45 mA	137 m (450 ft) @ 5 VDC 300 m (1,000 ft) @ 12 VDC
P225KPXSf, P225KPW26 Mullion Mount with Keypad	11.4 x 4.4 x 2.1 cm (4.5 x 1.75 x 0.84 in)	Up to 16.5 cm (6.5 in)	4.5 to 14 VDC, max. 45 mA	137 m (450 ft) @ 5 VDC 300 m (1,000 ft) @ 12 VDC
P325XSF, P325W26 Single Gang Mount	11.5 x 7.1 x 2.1 cm (4.6 x 2.8 x 0.84 in)	Up to 20.5 cm (8 in)	4.5 to 14 VDC, max. 45 mA	150 m (500 ft) @ 5 VDC 300 m (1,000 ft) @ 12 VDC
P325KPXSf, P325KPW26 Single Gang Mount & Keypad	11.5 x 7.1 x 2.1 cm (4.6 x 2.8 x 0.84 in)	Up to 20.5 cm (8 in)	4.5 to 14 VDC, max. 45 mA	150 m (500 ft) @ 5 VDC 300 m (1,000 ft) @ 12 VDC
P600 Long Range Reader	28.5 x 28.5 x 3.2 cm (11.25 x 11.25 x 1.25 in)	Up to 73 cm (29 in)	12 to 28 VDC, max. 1.5 A	137 m (450 ft) @ 5 VDC 300 m (1,000 ft) @ 12 VDC

ioProx Card Selection Chart

Model Number	Description	Dimensions (h x w x t)	Printable	Slot Punch
P10SHL	Clamshell Card	8.5 x 5.4 x 0.1 cm (3.4 x 2.1 x 0.07 in)	No	Vertical
P20DYE	ISO-Thin Card	8.5 x 5.4 x 0.07 cm (3.4 x 2.1 x 0.03 in)	Both Sides	Vertical or Horizontal
P30DMG	ISO-Thin Card with Unencoded Magnetic Stripe	8.5 x 5.4 x 0.07 cm (3.4 x 2.1 x 0.03 in)	Both Sides	Vertical or Horizontal
P40KEY	Key Tag	5.0 x 2.0 x 0.5 cm (1.9 x 0.9 x 0.55 in)	No	Key Ring Hole
P50TAG	Self-Adhesive Round Tag	2.5 cm diameter (1 in diameter)	No	No



Note that product images are not shown to scale.

Related Products



EntraPass Security Management Software



KT-400 Four-Door Controller



T.Rex Request-To-Exit Detector



Badge Printer

Approvals



Small Footprint Siren and Strobe Alarm



- Indoor/outdoor 15 watt armored siren
- 122dB sound output
- Warble sound output
- Rust-free aluminum die-cast
- Polarized 12VDC input with reverse polarity protection
- Dual-action reed tamper switch
- Up-front screw terminals for easier field wiring
- Suitable with use for most control panels
- Mounts directly to the wall or to 4" square back box
- 60,000 candle power strobe
- Available strobe lens colors: amber, blue, clear, red

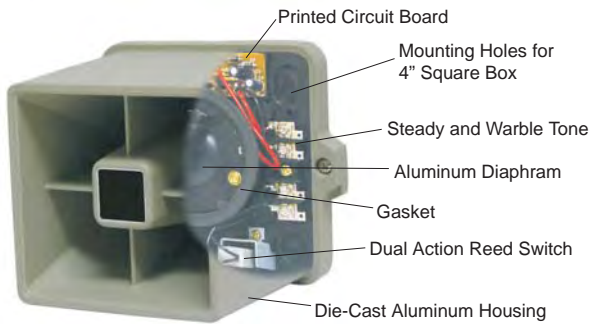

The Small Footprint Siren and Strobe Alarm is an indoor/outdoor, self-contained, 15 watt, armored security siren. The full featured siren consists of a single tone that delivers a warble sound output, light weight, rust-proof aluminum die-cast housing, a 122 dB output siren driver, and a dual action normally open reed plunger switch for normally closed loop. The armored siren does not require additional modules, metal boxes, tamper switches, special tools, or training to install and operate.

The device comes completely assembled and ready for installation.

The Siren Strobe combination is also available. It is a high quality, high output siren with a 60,000 candle power strobe with available lens colors: amber, blue, clear, and red.

The device is ideally suited for noisy, heavy machinery areas, warehouses, loading docks, print shops, busy production floors, or for indoor/outdoor applications where high quality and high output warning is required.

Model Number	Input Voltage	Current Draw	Operating Voltage Range	Strobe Specifications			Speaker Specifications		Operating Temperature Range
				Lens Color	Strobe Candle Power	Flash Rate	Sound Output	Tamper Contact Capacity	
51	6 -12V DC	.56 Amps	4.8 - 14.4 V DC	-	-	-	122dBA	0.3A @ 12V DC	14° F - 140° F -10° C - 60° C
51SA	12V DC	0.67 Amps	9.6 - 14.4V DC	Amber	60,000	20 - 100 times/min.			
51SB				Blue					
51SC				Clear					
51SR				Red					

Small Footprint Siren and Strobe Alarm

Dimensions: inches (mm)

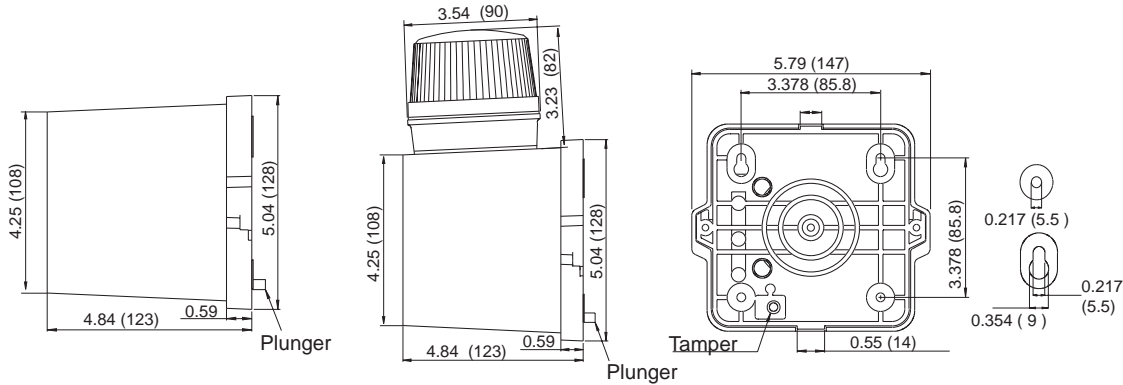

Installation

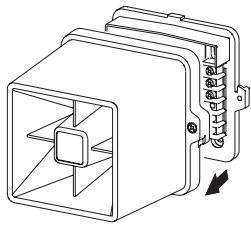

Step 1

Separate the housing from the back plate.

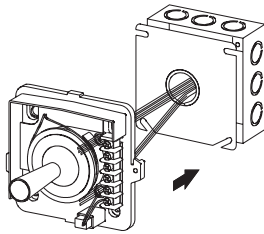

Step 2

Mount the back plate directly to the wall or to a 4" square box.

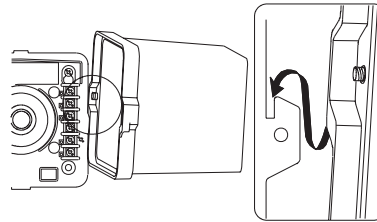

Step 3

Place the housing over the built-in hook to free your hands during wiring.

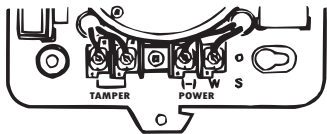

Step 4

Connect the siren wires to the terminal strip as indicated above, and re-install the cast iron housing.

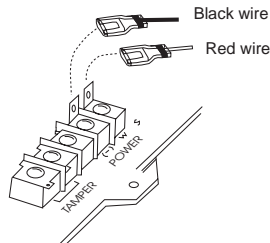

For SSX-51S

Connect the Red wire from the strobe to the (w) terminal and the Black wire to the (-) terminal on the back plate as indicated.

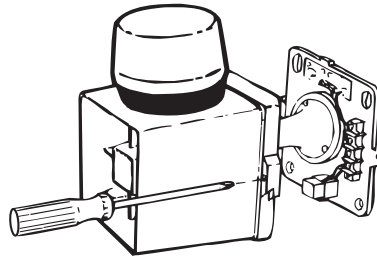

Step 5

Re-install the cast iron housing, making sure it aligns properly with the back plate before securing the screws.

Exit Devices - 120/1200/1300 Series

High Security Exit Devices

120 Series

Switch Bar
(no latch or strike)

1200 Series

High-Security
Mechanical
Rim Exit Device



1300 Series

High-Security
Electric
Rim Exit Device



Lever Trim 08

Key locks or unlocks trim
UL Certified to
ANSI/BMHA
A156.3-1994,
Grade 1



Pull Trim 03P

Entrance by key retracting
latch bolt



Patented Interlocking
Strike and Latch



Features

1200 / 1300 Exit Devices

- cULus listed (3-hour Fire Exit Hardware)
- Weather resistant for outdoor use
- Current of less than 800mA for 12VDC and 400mA for 24VDC is required to unlock the device or to dog it unlocked. (Fire rated devices must be powered through contact of a fire-alarm system delay)
- All devices re-latch
- Camlock and cylinder dogging available (for non-fire labeled doors)
- Choice of 3 standard alarm modules
- Standard lengths for 36" (3 feet) and 48" (4 feet) doors
- Can be field cut for undersized doors
- Non-handed for installing on all types of doors, including narrow stile aluminum.
- High security, exceeding a 1" dead bolt
- Model 1300 includes a 12/24VDC dual voltage continuous-duty solenoid which provides a remote unlock feature for controlled entry.

120 Switch Bar

- SPDT or two SPDT signal switches deactivate electric locks and/or activate a remote alarm when push bar is pressed.

Lever and Pull Trim

- Compatible with 1200/1300 Series exit devices

Model 08 Lever Trim

- Handing standard LHR; field reversible to RHR
- Vandal-resistant - Lever is not restricted in the locked position
- UL certified for fire doors

High Security Exit Devices

The 1200 and 1300 Series exit devices resolve the conflict between life safety and security.

Both 1200 Mechanical and 1300 Electric Series exit devices feature a patented latch that rotates to engage and grip the specially designed strike. This unique interlocking grip action secures the door to the jamb without conventional roller strikes or retracting latches.

In addition an interlocking mechanism located in the chassis offers a double interlocking system which makes these exit devices virtually impossible to tamper with, pry or force open.

The attractive lever trim can be used on the exterior side of the door for access.

Options & Accessories

120/1200/1300 Series

1200C/1300C	Cylinder dogging
1200D/1300D	Cam lock dogging
1200F/1300F	Fire labeled exit device, no dogging
10	Alarm module (9V battery supplied)
20	10-26 VDC alarm module (remote power with battery backup; 9V battery supplied)
30	10-26 VDC alarm module (remote power only)
SS1	SPDT Signal Switches
SS2	Two SPDT Signal Switches
LMS	Lock Monitor Switch
DDS	Double Door Strike

Highlights

- Strong Protection, Fast Release
- Non-handed
- Interlocking strike & latch design (1200/1300 Series)
- 3-Year Limited Warranty
- Made in the USA

Applications

- Use 120, 1200 or 1300 Series with any 3 or 4-foot-wide doors
- Use with all types of doors, including narrow-stile aluminum
- Any exterior door exposed to possible tampering

Trim Options

08-L	Lever Trim
08N-L	Narrow stile lever trim
08E-L	Electrified lever trim
08NE-L	Narrow stile electrified lever trim
03-P	Pull Trim

Finishes

28	Aluminum (BHMA 628)
40	Dark Duranodic (BHMA 710)

120/1200/1300 Series

03P/08 Trim

Specifications

1200/1300 Series	
Signal Switches*	Activated by depressing push bar. Switches can be specified for all types of access controls. SS1 – SPDT rated 3A@30VDC (Inductive), 4A @ 30VDC (Resistive) SS2 – 2SPDT rated 3A @ 30VDC (Inductive), 4A @ 30VDC (Resistive)
Lock Monitor Switch	For remote alarm monitoring of latch position. Normally opened, normally closed contacts.
Push Bar Inserts	Black vinyl insert supplied. Allows inserts to be added by removing push bar end cap and sliding insert into the groove of the push bar.
Patented Interlock	Strike and latch are stainless steel, heat-treated and tempered. Tensile strength 200,000 PSI.
Alarm Module	10 – Operated by a 9V alkaline battery (supplied) 20 – Remotely powered field-selectable 10 to 26VDC power with a 9V battery backup (supplied) 30 – Remotely powered field-selectable 10 to 26VDC power. 1300 Series can be unlatched remotely without sounding the alarm. When cylinder supplied by others, specify 15/16" through 1-1/8" with Yale A Cam (Cylinders sold separately). Signal switches SS1 and SS2 are available with all alarm modules.
Alarm Module Current Draw	Alarm Module 10 – 0.5 microA in Standby position; 16mA when sounding Alarm Module 20 – 0.5 microA in Standby position; 16mA when sounding Alarm Module 30 – 0.5 microA in Standby position; 16mA when sounding
Alarm Horn Power	110db piezo horn; field-selectable continuous horn or 3 to 5-minute sound and reset; field-selectable intermittent beep or steady horn. Activated by depressing push bar when in the "Alarm On" position.
Low Battery Alert	Audible chirp indicates low battery (1 chirp/minute). Activated by 7.6 volts
Current Draw	Electrified Trim 155mA@24VDC 1300 Solenoid 800mA @ 12VDC, 400mA@24VDC
1200/1300 Series Certification	Accepted by NYC MEA 337-92M, Listed by CA State Fire Marshal; ADA compliant Models with A.C or D suffix; cULus Listed Panic Hardware ANSI/BMHA A156.3-2001, Grade 1, Models with F suffix; cULus Fire Exit Hardware rated 3 hours, ANSI/BMHA A156.3, Grade 1 Conforms to ANSI/UL10C and UBC 7-2 (1997)

*Rating for SS1 and SS2 applies to Model 120 also.

120/1200/1300 Series

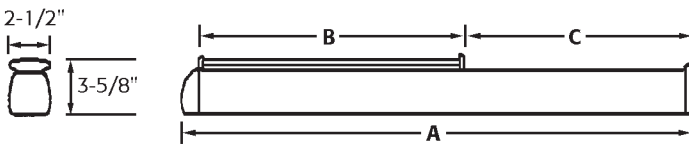

08 Series Lever Trim
 UL Certified to ANSI/BHMA
 156.3, Grade 1
 ADA Compliant

MODEL NO.	A	B	C	DOOR WIDTH	FIELD-CUT C FOR DOOR WIDTHS
120A/1200A/1300A	34-3/8"	18"	15"	36"	22" to 35"
120D/1200C & D/1300C & D	34-5/8"	18"	15"	36"	24" to 35"
1200F/1300F	34-3/8"	18"	15"	36"	27" to 35"
L120A/L1200A/L1300A	46-3/8"	24"	21"	48"	28" to 47"
L120D/L1200C & D/L1300C & D	46-3/8"	24"	21"	48"	30" to 47"
L1200F/L1300F	46-3/8"	24"	21"	48"	39" to 47"

NOTE: Not to scale. Specifications are subject to change without notice.

EntraPASS also offers a complete line of Electromagnetic Locks, Electric Strikes, Power Supplies, Switches, Keypads & Readers, Exit Devices, Systems & Door Hardware.