

SELF-STORAGE DOOR INSTALLATION INSTRUCTIONS

IMPORTANT NOTICE

In the following text, the word:

WARNING: Indicates that serious injury or death can result from failure to follow instructions.

CAUTION: Indicates that minor injury or property damage can result from failure to follow instructions.

NOTE: Indicates that special attention should be given to the instructions.

CAUTION: Use proper lifting equipment and correct procedures to avoid injury.

DO NOT CUT THE TAPE OR PLASTIC, which holds the door in a roll. You will be told at a later time exactly when to cut these items. No guarantee will be given or responsibility accepted by the manufacturer if the door is not installed as instructed. For proper operation, follow the instructions given. PLEASE review ALL instructions before starting actual work.

WARNING: Overhead doors are large, heavy objects that move with the help of springs under high tension. Moving objects and springs under tension can cause injuries. Your safety and the safety of others depends on reading and following the information in these instructions. We recommend that only properly trained personnel should install and tension doors.

POTENTIAL HAZARD	EFFECT	PREVENTION
Moving Door	Can cause serious injury or death	Keep people clear of opening while door is moving. Get help or use support when lifting new door into place.
High Spring Tension	Can cause serious injury or death	Installation and repairs must be made by a trained service person using proper tools, methods and instructions. Before adjusting torsion spring, make sure door is fully open and curtain is wrapped on drums.

SELF-STORAGE DOOR SERIES

General Information

1. CHECK DOOR OPENING

- A. Check the width and height of the door opening and verify the measurements against the sizes shown on the door packing slip.
- B. Check door jambs for plumb to ensure proper door alignment and performance.
- C. Check header and floor level to ensure proper door alignment and performance.
- D. Check to be sure that there is sufficient side clearance at the jambs and at the head room above the door opening. **(See Table A.)**
- E. The jamb surface, to which the guide is to be attached, should be flush for mounting purposes.

Table A

MINIMUM CLEARANCE*

Opening Height	Head Room	Side Room
Thru 7' - 4"	16"	3-1/4"
Thru 8' - 8"	16-1/2"	3-1/4"
Thru 10' - 0"	18-1/2"	3-1/4"

2. DOOR ARRANGEMENT

- A. Lay door on a clean floor inside of building and in front of opening. **(See Figure 1.)**

NOTE: Door can be damaged if laid on an unclean surface.

- B. Distribute parts bags, guides, stops and brackets.

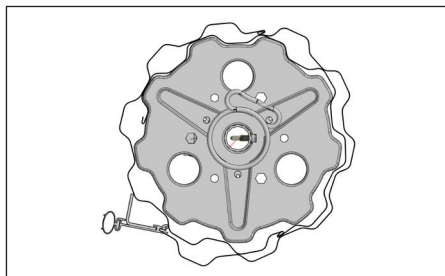

Right End
Figure 1

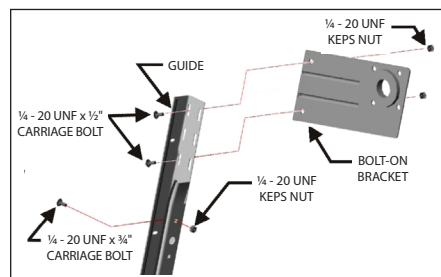

Standard Bracket
Figure 2

3. BRACKET TO GUIDE ATTACHMENT

Standard Bracket

Attach each bracket to the top of the guide using two (2) 1/4 - 20 UNF x 1/2" long carriage bolts and two (2) KEPS nuts **(as shown in Figure 2)**. Place one (1) 1/4 - 20 UNF x 3/4" long carriage bolt and one (1) 1/4 - 20 UNF KEPS nut into the guide where the head stop will be attached later in Section 9. **(See Figure 2.)**

NOTE: Do not attach head stop at this time.

Extended Bracket

(for doors taller than 8' - 8")

Attach each extended bracket to guide with two (2) 1/4 - 20 UNF x 3/4" long carriage bolts and two (2) 1/4 - 20 UNF KEPS nuts. **(See Figure 3.)**

Temporarily install one (1) 1/4 - 14 x 1" long TEK fastener through the lowest extended bracket angle hole into the back of the guide. **(After bracket is installed on jamb, this TEK fastener will be removed.)** Also, place one (1) 1/4 - 20 UNF x 3/4" long carriage bolt and one (1) 1/4 - 20 UNF KEPS nut into the guide where the head stop will be attached later, in Section 9. **(See Figure 4.)**

NOTE: Do not attach head stop at this time.

SELF-STORAGE DOOR SERIES

General Information

4. BRACKET TO AXLE ATTACHMENT

Slide brackets onto axle and secure each side with a cotter pin through the holes at each end of the axle. (See Figure 5.)

NOTE: The bearing may fit snugly around the axle. Tap lightly on the bearing's inner race to move it along the length of the axle. Only the LEFT BRACKET will include the Tensioner Assembly.

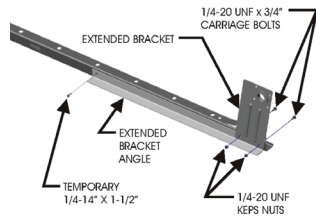

Right Guide and
Extended Bracket
Figure 3

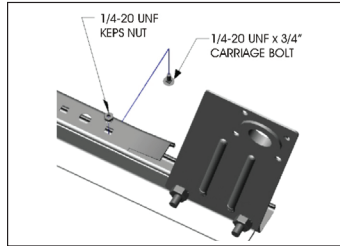

Head Stop
Preparation
Figure 4

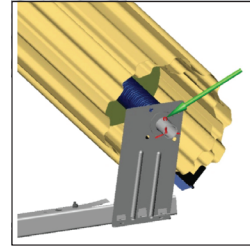

Right End
Cotter Pin
Figure 5

5. SPRING ATTACHMENT

Place the left spring hook over the left end tensioner tang as shown in Figure 6B. Ensure that the spring hook fully engages the tensioner tang. The spring alignment sleeve (Figure 6A) must be inside spring.

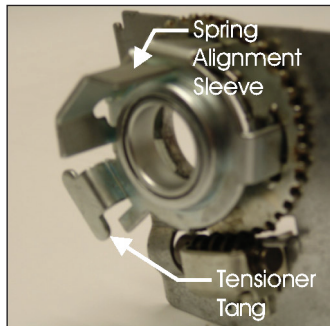

Tensioner Without Spring
Figure 6A

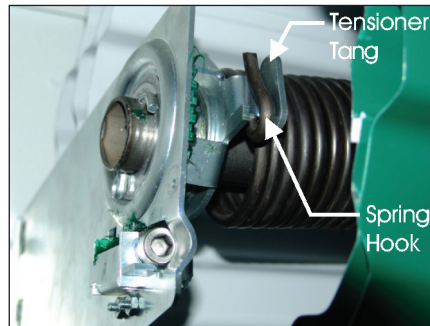

Left End Spring Attachment
Figure 6B

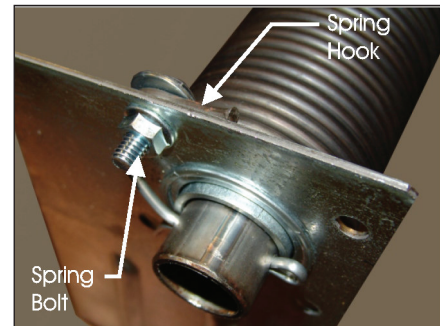

Right End Spring Attachment
Figure 6C

NOTE: For opening heights over 8' - 8" through 10' - 0" with an opening width over 6' - 0" through 9' - 0," and any height door with an opening width greater than 9' - 0" will be supplied with two (2) springs. Both springs must be properly attached to ensure proper operation of door. For second spring attachment see Figure 6C. Right end spring may use any of the four (4) holes at each corner.

SELF-STORAGE DOOR SERIES

General Information

6. RAISING DOOR ASSEMBLY

Using two (2) people, move the curtain assembly close to the door jambs. Lift door vertically at the areas indicated by the arrows in **Figure 7**. Lean the curtain assembly against the door jambs and, after ensuring that the guides are the correct width, have one person hold the assembly in place. The second person attaches the door bracket by installing a fastener in the bottom hole of the door bracket.

WARNING: Do not leave door unattended.

WARNING: Guides are not designed to support curtain weight during a one-man tilt-up installation. Attempting a one-man tilt-up installation can result in serious bodily injury and/or damage to the door.

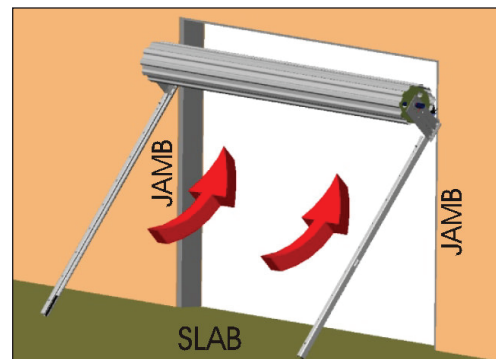

“Two Man Tilt Up”
Figure 7

7. LEFT GUIDE AND BRACKET INSTALLATION TO JAMB

Attach left guide and bracket to jamb with fasteners provided. (See **Table B.**) Make sure guide is plumb.

NOTE: The bottom and middle guide anchor positions must be the correct width. The top anchoring position should be approximately 1/4" wider on each side of the top and flush on each side of the bottom to ensure ease of entry by the curtain as it descends into the guide rails. (See **Figure 8.**)

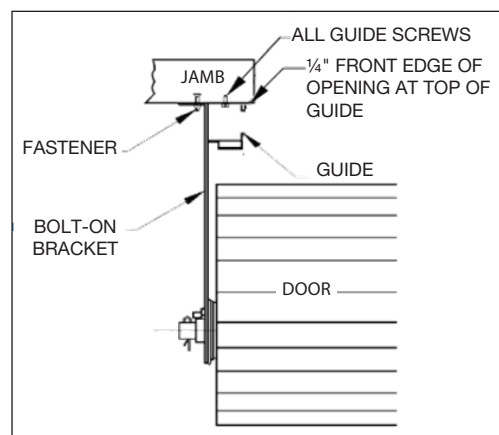

Top View
Figure 8

Table B

Items	Jamb	Fastener	Drill Size
Brackets	Concrete or Filled Block	5/16" x 1-1/2" Sleeve Anchor	5/16" Diameter
Guides	Concrete or Filled Block	5/16" x 1-1/2" Sleeve Anchor 1/4" x 1-1/4" Masonry Fastener	5/16" Diameter
Brackets and Guides	Steel-Structural	1/4 - 14 x 1" TEK Fastener	None
	Steel-Rollup Frame	1/4 - 14 x 1" TEK Fastener	None
	Wood	1/4 - 14 x 1" LAG Fastener	None

NOTE: Three (3) fasteners are provided for each extended bracket. Three (3) fasteners are provided for each guide for doors thru 8'-8" tall and four (4) for doors over 8'-8" tall.

WARNING: Door can fall if not securely fastened to jambs. All fasteners attaching bracket to jamb must fit securely into a structural member or surface. If door falls, serious bodily injury and/or damage to door can result.

NOTE: Do NOT weld guides to jambs.

SELF-STORAGE DOOR SERIES

General Information

8. RIGHT GUIDE AND BRACKET INSTALLATION TO JAMB

Attach right guide and bracket to jamb. Use a tape measure at the locations indicated in **Figure 9** to set the proper guide to curtain end clearance. See example to the right and below.

EXAMPLE

If your curtain measures 8' - 3" in width, then the distance from the outside of the left guide to the outside of the right guide should be 8' - 3 ¾" to 8' - 4" at measuring point "A" and 8' - 3 ½" at measuring point "B."

NOTE: If extended brackets are used, remove the temporary TEK fasteners from the bottom hole of both extended bracket angles at this time.

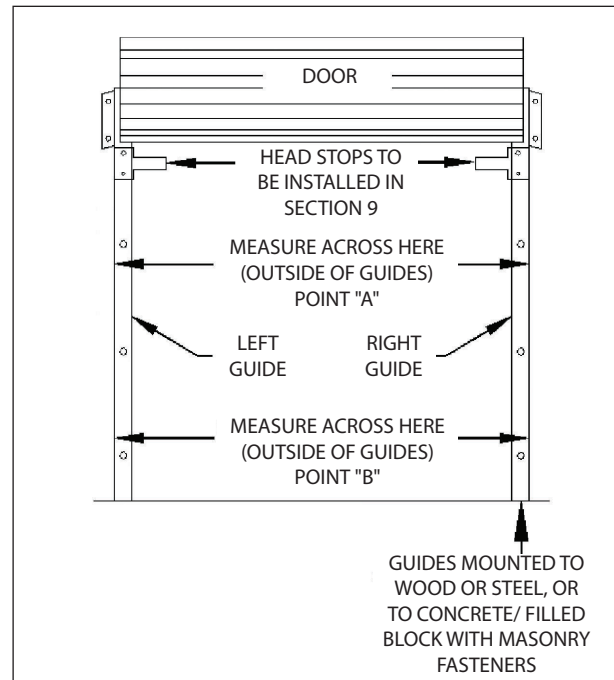

Inside View
Figure 9

9. SETTING SPRING TENSION

After the door is completely secured to the building, it is time to tension the spring.

WARNING: High spring tension installation, repairs and adjustments must be made by a trained service person using proper tools, methods and instructions. Once the door has been rotated, it is now under high spring tension.

Rotate the door in the direction indicated two (2) full rotations. (See **Figure 10**.) While FIRMLY HOLDING the door at the bottom bar, cut the tape and plastic which holds the door in a coil. (See **Caution Below**.) Roll the curtain down into the guides. Install head stops by using the bolts and nuts that were previously attached to the guides in Section 3.

CAUTION: When cutting OFF tape and plastic be careful to NOT CUT or damage bottom bar and rubber astragal.

TEMPORARILY ADDING THE HEAD STOPS

- Remove the ¼ - 20 UNF KEPS nut from the ¼ - 20 UNF carriage bolt that was attached in Section 3. (See **Figure 4**.)
- Place the head stop on the ¼ - 20 UNF carriage bolt with its tab facing toward the curtain (as shown in **Figure 12**) using the ¼ - 20 UNF KEPS nut previously removed.
- Tighten the ¼ - 20 UNF KEPS nut onto the carriage bolt until secure.
- Repeat the previous steps on the other guide, using the other head stop included in this package.
- When completed, both head stops should face each other (as shown in **Figure 9**).

WARNING: Never bolt head stops to guides and then bend them out to allow passage of the bottom bar. This improper method could result in the bottom bar bypassing the head stops. Should this happen, the door will rapidly uncoil causing serious injury and/or damage to the door.

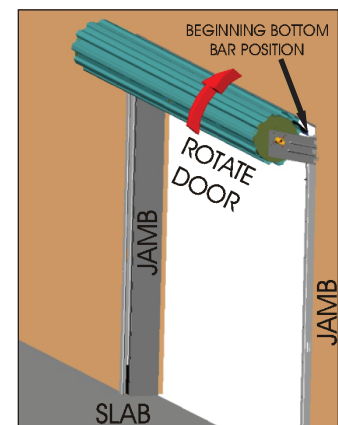

Right End View
Figure 10

SELF-STORAGE DOOR SERIES

General Information

RAISE AND LOWER THE DOOR TO TEST THE SPRING BALANCE

- A. If door is easy to close but hard to open: INCREASE SPRING TENSION.
- B. If door is hard to close but easy to open: DECREASE SPRING TENSION.
- C. If more than four (4) revolutions of the door are required to get proper door operation, PLEASE contact manufacturing immediately.



Figure 11A

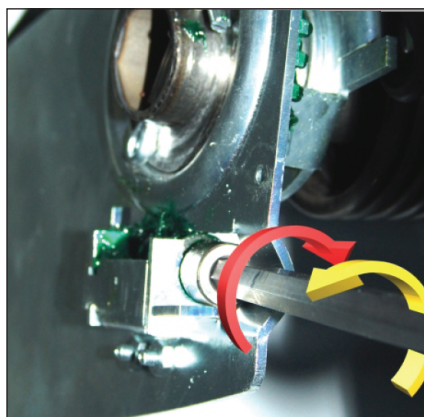

Figure 11B

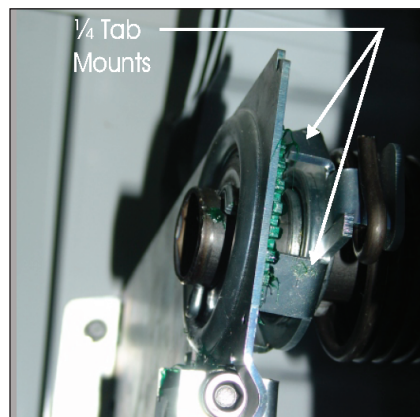
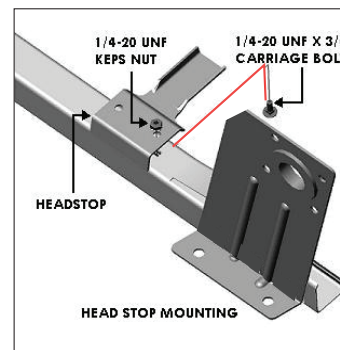

Figure 11C

TO ADJUST SPRING BALANCE, FOLLOW THESE STEPS:

- A. Engage a $\frac{5}{16}$ " Allen wrench into the worm drive (Figure 11A).
- B. Rotate the worm drive in a clockwise direction to reduce tension (red arrow) on the spring and counter-clockwise to increase tension (yellow arrow) on the spring (Figure 11B).
- C. Using the four (4) tab mounts connecting the bearing to the gear, count the number of $\frac{1}{4}$ turns added/subtracted. Each tab represents $\frac{1}{4}$ turn (Figure 11C).
- D. Repeat raising and lowering of door after each $\frac{1}{4}$ turn to test the tension and evaluate the need for further adjustment.



Head Stop Mounting
Figure 12

WARNING: If rope is applied to door for operation, ensure rope DOES NOT form a loop.

10. HANDLE(S), ROPE AND LATCH INSTALLATION

- A. Attach handle(s), rope and latch assembly to the door. (See Figure 13.)
- B. Be sure to use nylon insert locknuts on the latch attachment bolts. If cylinder lock feature is used, attach latch back plate to back of curtain.
- C. Holes are punched in the bottom angle for insertion of the pull rope.

NOTE: If the standard DBCI Mini Latch is requested, the latch will be factory installed.

If installing a non-standard latch, attach the two (2) pieces of cushion tape vertically across the corrugations on inside of curtain over the nuts which hold the Mini Latch onto the curtain. This tape prevents scratching of the face of the door to occur.

NOTE: Due to variances in manufacturing and/or site conditions, the latch hole in the guide may require adjusting in the field.

SELF-STORAGE DOOR SERIES

General Information

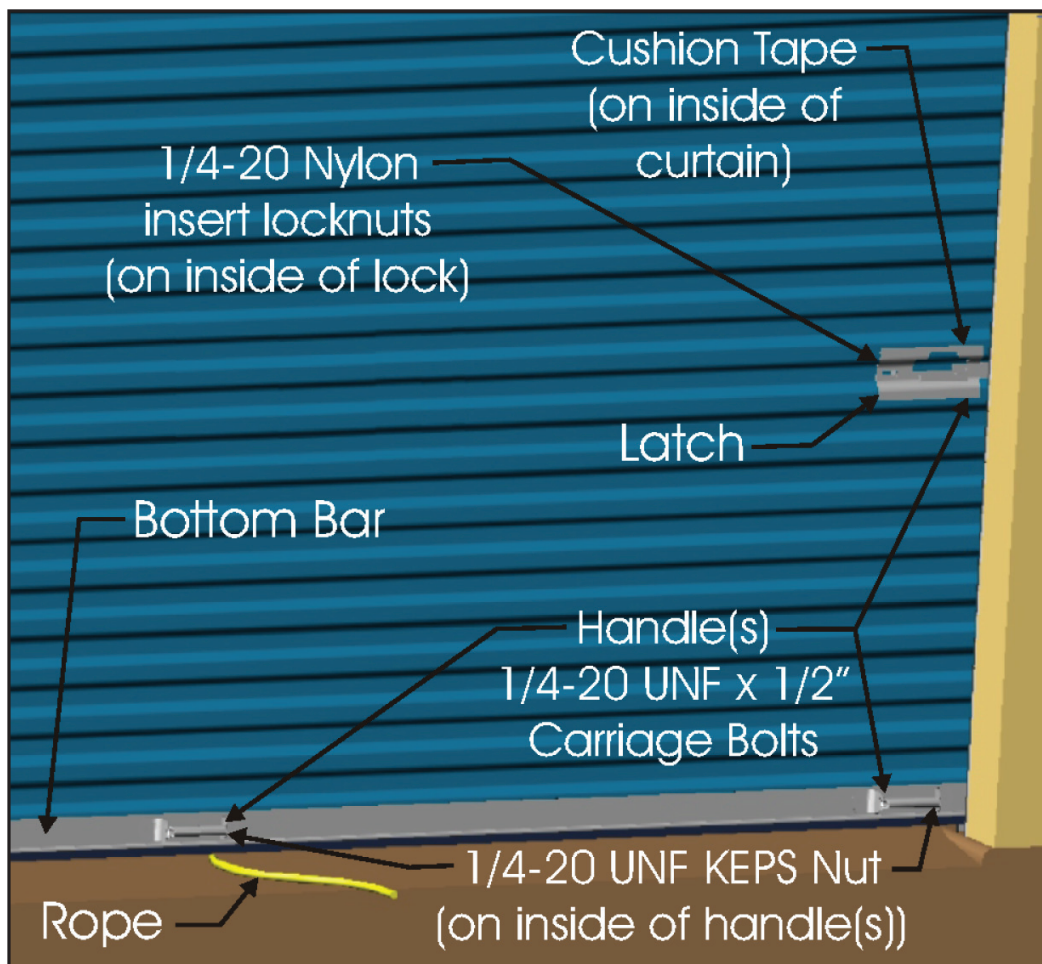

Figure 13

MAINTENANCE INSTRUCTIONS

In order to promote longevity of your door, it is recommended that the following maintenance procedures be performed approximately one to two times per year:

Astragal: Periodically clean the dirt off of the length of the astragal.

Springs: Periodic adjustments to the spring tension may be necessary. A light coat of lithium-based grease should be applied to springs to reduce friction and prevent rust.

Guide Strips: Guides are self-lubricating but must be kept free from dirt to work their best. Wipe dirt from inside of guides to assure smooth operation of doors. A greaseless lubricant, such as silicone spray, may be used.